

PVC & CPVC Fittings & Valves

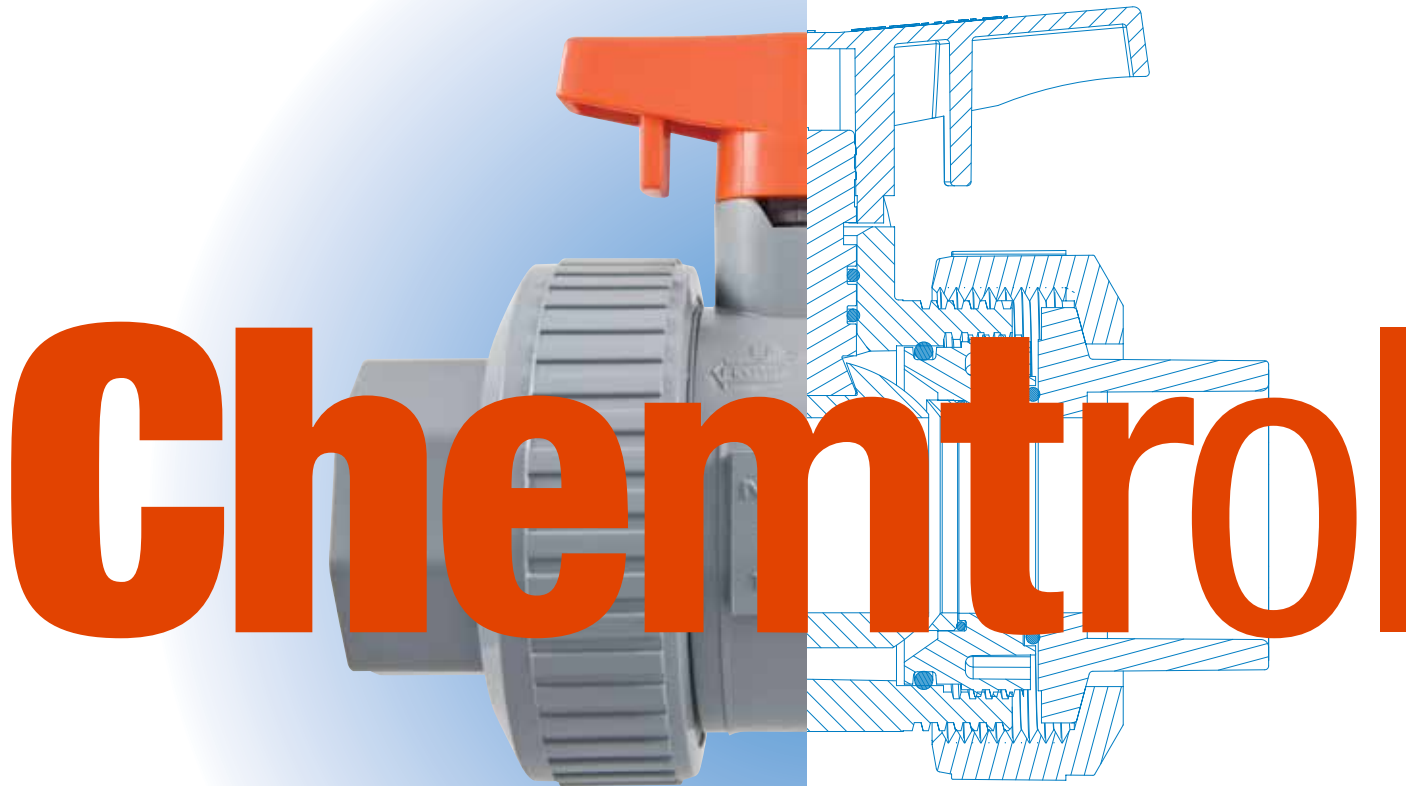

For ideas that fit your industrial flow-control applications, you can count on Chemtrol. Our high quality line of thermoplastic valves, fittings, and pipe are ideas that last. Ideas that save money. Ideas whose time has come.

Proven dependability.

Chemtrol flow-control products are unsurpassed in performance and longevity. With more than 55 years of experience in industrial thermoplastics, Chemtrol offers dependable products that work in the most demanding environments.



Innovative technology.

Great ideas flow from Chemtrol in PVC, CPVC, PP, and PVDF products for a wide range of flow-control applications.

Technical service and sales support.

Our technical specialists are some of the best in the business. As part of your team, they provide expert advice, solve problems, and assist you every step of the way.

Our distributors, sales professionals, and service representatives offer ideas, answer questions, and put their knowledge to work for you.

Education and training.

We help you learn about the benefits of thermoplastics through excellent programs: classes and seminars specific to your industry, presented at our manufacturing facility, or product and application-specific seminars conducted in the field. Our high-quality product and technical manuals are available on request, and a full listing of Chemtrol products is provided on our web site, www.chemtrol.com



Introduction	4
Introduction to Chemtrol	
Materials	5
Chemical Resistance	5
Product Line	6
Product Guide	8
Ball Valves	
PVC & CPVC Tru-Bloc® Model D Ball Valves	9
PVC & CPVC Tru-Bloc® Model C Ball Valves	10
PVC & CPVC Vented (Bleach) Ball Valves	11
PVC & CPVC 3-Way Ball Valves	12
PVC Compact Economy Ball Valves	14
Butterfly Valves	
PVC Butterfly Valves, Model C	15
PVC & CPVC Butterfly Valves, Model B	16
Ball Check Valves	
PVC & CPVC True Union Ball Check Valves	17
Angle & Globe Valves	
PVC Angle and Y-Pattern Globe Valves	18
Lab Valves	
PVC Chemcock® and Calibrated-Needle Valves	19
Valve Accessories	20
PVC Schedule 80 Fittings	24
CPVC Schedule 80 Fittings	34
Reference Data	43
Standards	53
Product Specifications	54
Warranty	59

Copies of the Chemtrol publications are available for download on www.chemtrol.com.

Introduction to Chemtrol

With more than 55 years of experience in industrial thermoplastics, Chemtrol offers dependable products that work in the most demanding environments.

The premium line of quality Chemtrol® valves are lightweight, corrosion-resistant, and maintenance-free – saving you time and money.

For specific recommendations of chemical compatibility, see the *Chem-Guide*. For engineering data related to plastic piping system design and installation and maintenance instructions, see the *Chemtrol Thermoplastic Piping Technical Manual*. All Chemtrol publications are available for download on www.chemtrol.com in PDF format.

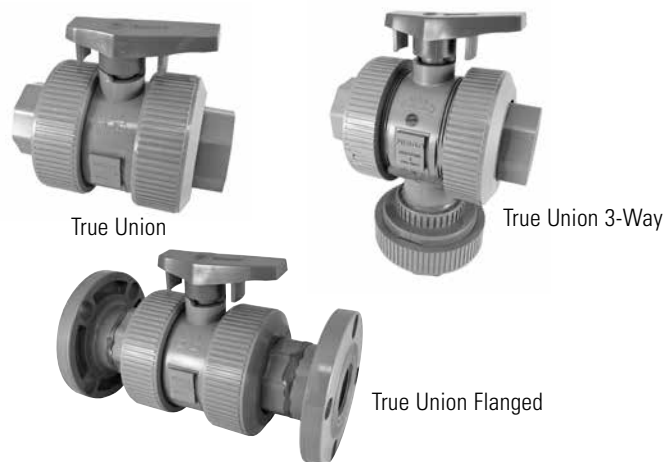

True Union Ball Valves

The True Union feature, a Chemtrol introduction, an exclusive Chemtrol introduction, so revolutionized the industrial plastic valve industry that it has become the standard followed by all major manufacturers. The purpose of the design is to permit the valve cartridge, i.e., the body containing all operational components, to be easily lifted from the piping system for servicing/replacement when the union nuts are backed off. Easy repair/replacement, interchangeability, distribution availability, technical service, and reliable quality are the synergistic rationale many plants and original equipment manufacturers have embraced while standardizing on Chemtrol® True Union Ball and Check Valves.

The laying length of the body and the heavy-duty modified-acme threads in the union connections to the body have not changed in the four distinct models' 40-year history of the valve. This permits fouled valve replacement with a new body cartridge, which will fit the old union nuts. No change in piping length is required.

The distinctive orange handle indicates "open/close" and direction of flow at a distance. And molded-in arrows on top of the handle dictate rotational direction to personnel for easy operation within 90° stops. For applications requiring handle removal, the D-ring stem flats indicate "open/close" and a molded-in arrow on top of the stem indicates flow direction.

The Evolution of Chemtrol® Ball Valves

As a result of continuous testing and improvements since the inception of the True Union Ball Valve, three distinct model changes have occurred. The original True Union Model A design had a seat-carrier that slid into the smooth bore of the valve body, held in place by the external nut and end connector. Tightening the external nut adjusted the compression of the PTFE seat onto the ball.

The first major evolution to the True Union Ball Valve, Model B, introduced the Tru-Bloc concept, a functional safety feature. With this design a separate threaded retainer locked the seat-carrier into the body and prevented the seat-carrier from being extruded out of the valve body when the external nut was removed. This change is intended to prevent pressure on the other side of the valve from ejecting the internal components and fluid medium out of the open valve end and to further prevent possible injury to persons or property.

The Model C seat-carrier design was modified to include an external thread which mated into the valve body threads, eliminating the separate retainer. This modification also eliminated the adjustment of the seat-carrier by the external nut and end connector, resulting in a sealing envelope that was independent of external forces. An energized O-ring was added under the PTFE seat that provided automatic adjustment to compensate for seat wear. This design modification continued the Tru-Bloc feature, preventing the seat carrier from being extruded out of the valve body when the external valve nut was removed.

Manufactured in PVC and CPVC through 2", the current Model D ball valve's seat-carrier internal threads and the external union nut threads were strengthened to provide an increased pressure rating of 250 psi at 73°F and improved the pressure ratings at higher temperatures. The end connector design was modified to provide wrench flats. The union nut OD was changed to provide improved gripping for strap wrenches. The Model D design continued the sealing envelope that was independent of external forces with an energized O-ring under the PTFE seat that provided automatic adjustment to compensate for seat wear. The Tru-Bloc® feature was also retained.

Materials

PVC

(Polyvinyl Chloride) PVC conforming to ASTM D1784, Classification 12454, formerly designated Type I, Grade 1, is the most frequently specified of all thermoplastic piping materials. It has been used successfully for more than 55 years in such diverse areas as chemical processing, industrial plating, chemical drainage, fresh and wastewater treatment, chilled and tower cooling water, deionized water manufacture and distribution, and irrigation sprinkler systems. PVC is characterized by high physical properties and resistance to chemical attack by strong acids and other oxidizers, alkalis, salt solutions, some organic chemical solutions, and many other chemicals. However, it is attacked by non-ionic surfactants, some vegetable oils (e.g., peanut), and many organic chemicals such as polar solvents (e.g., ketones), aromatics (i.e., benzene ring structure), and chlorinated hydrocarbons. The maximum service temperature of PVC is 140°F. With a design stress of 2,000 psi at 73°F, the long-term hydrostatic strength of PVC is as high as any of the major thermoplastic materials being used for solid piping systems. PVC is joined by solvent cementing, threading, or flanging.

CPVC (Corzan®)

(Chlorinated Polyvinyl Chloride) CPVC conforming to ASTM D1784, Classification 23447, is a resin created by the post-chlorination of a PVC polymer. The material's resistance to chemical attack is almost identical to that of PVC. And the physical properties of CPVC are very similar to those of PVC at 73°F, but the additional chlorine in the CPVC polymer extends its maximum service temperature to 210°F. For example, the design stress for CPVC is 2,000 psi at 73°F, identical to that of PVC. But its strength is only reduced to 500 psi at 180°F, as compared to 440 psi for PVC at 140°F. For more than 35 years, CPVC has proven to be an excellent material for hot corrosive liquids, hot and cold water distribution, and similar applications above the useful temperature range for PVC. CPVC may even be chosen over PVC in the 110°F to 140°F temperature range because its higher strength-at-temperature, requiring less frequent piping supports, can translate to a more favorable overall installed cost than PVC. CPVC is joined by solvent cementing, threading, or flanging.

PVDF (Kynar®)

(Polyvinylidene Fluoride) PVDF homopolymer conforming to ASTM D3222, Type I, Grade 2, is a tough, abrasion-resistant fluorocarbon material that has a design stress of 1,360 psi at 73°F and a maximum service temperature of 280°F. It has versatile chemical resistance to salts, strong acids, dilute bases, and many organic solvents, such as the aromatics (i.e., benzene ring structure), the aliphatics (i.e., paraffin, olefin, and acetylene hydrocarbons), and the chlorinated groups. And PVDF is ideally suited for handling wet or dry chlorine, bromine, and other halogens. However strong bases and some organic chemicals such as polar solvents (e.g., ketones) and esters attack it. No other solid thermoplastic piping material can approach the combined strength, working temperature, and chemical resistance characteristics of PVDF. It is joined by the thermo-sealing socket fusion process, threading, or flanging.

PVDF, absent of any color pigment, is transparent to ultraviolet light. So while PVDF is one of the few plastic materials that is not degraded by UV radiation, exposure of the fluid medium inside a piping system to direct sunlight can frequently adversely affect its stability. Therefore, all PVDF piping components that Chemtrol produces for general chemical service, contain an FDA-approved red pigment to mask the penetration of UV rays.

Natural Kynar® PVDF Type I (polymerized in emulsion) homopolymer is notably free of metallic ions and foreign organic compounds. And since the resin does not require processing or other external additives to aid manufacturing or long-term stability, the hard-polish surface of components will remain intact, so that piping systems will not release particulate to the fluid medium. Further, there will be no surface micropores to encourage biological growth. Natural Kynar® systems are intended for ultra high pure water and chemical services, such as electronics, pharmaceuticals, and processed foods and beverages.

PP

(Polypropylene) PP as specified by ASTM D4101, is a member of the polyolefin family of pure hydrocarbon plastics. Although PP has half the strength of PVC and CPVC, with a design stress of 1,000 psi at 73°F, it may have the most versatile chemical resistance of the thermoplastic materials identified as the sentinels of industrial piping. Consider the fact that there are no known solvents for PP. As a result, it has been the material of choice for drainage of mixed industrial chemicals for over 40 years. As pressure piping, PP has no peers for concentrated acetic acid or hydroxides. It is also suitable for milder solutions of most acids, alkalis, salts, and many organic chemicals, including solvents. The nemeses for PP are strong oxidizers, such as the hypochlorites and higher concentrations of sulfuric, nitric, and hydrofluoric acids. They are Environmental Stress Cracking (ESC) agents for PP, meaning that time-to-failure is a function of the combined variables of concentration and temperature of the fluid and stress. Although PP is not recommended for some organic chemicals, such as polar and chlorinated solvents and the aromatics, the concern is permeation through rather than catastrophic damage of the molecular chain.

Black PP used in Chemtrol products is formulated with a minimum 2.5% carbon black. The plastic pipe industry recognizes PP formulated with this level of carbon black as suitable for long-term outdoor service.

Chem-Pure® Natural PP utilized to produce Chemtrol® piping products was selected because of its extremely low content of metals, organic compounds other than naturally pure propylene, and free ions. No pigments or other adulterants (natural) are added to the plastic resin. Chem-Pure® systems are intended for high purity chemicals or DI water. Chem-Pure systems are intended as an economic alternative to the ultra high purity PVDF systems typically found in the highly sophisticated electronic semi-conductor industry.

FKM

(Fluoroelastomer) FKM is compatible with a broad spectrum of chemicals. Because of this extensive chemical compatibility, spanning wide ranges of concentration and temperature, FKM has gained wide acceptance as a material of construction for valve o-rings and seats. These fluoroelastomers can be used in most applications involving mineral acids (with the exception of HCl), salt solutions, chlorinated hydrocarbons, and petroleum oils. FKM is not recommended for most strong alkali solutions.

EPDM

(Ethylene-propylene-diene monomer) EPDM is a terpolymer elastomer that has good abrasion and tear resistance and offers excellent chemical resistance to a variety of salt, acidic, and organic chemical solutions. It is the best material for most alkali solutions and hydrochloric acid, but is not recommended for applications involving petroleum oils or most strong acids.

PTFE

(Polytetrafluoroethylene) PTFE has outstanding resistance to chemical attack by most chemicals and solvents. PTFE has a temperature rating of -200°F to +500°F. It is a self-lubricating material used as a seat and/or bearing material in most Chemtrol® valves.

Chemical Resistance

While thermoplastic piping systems are useful in general water service because they are light-weight, easy to install, and cost-effective, they excel in corrosive environments, such as water and wastewater treatment, food and pharmaceuticals, chemical processing, mining, power plants, oil refineries and more. Choosing the proper material for corrosive fluids can be handled by consulting NIBCO's chemical resistance guide and understanding the effect that temperature will have upon plastic materials' strength.

Chemical resistance is the ability for a particular plastic material to maintain properties in contact with a chemical. To ensure comprehensive chemical compatibility, a piping system must take into consideration the chemical resistance of all system components, including, but not limited to, plastic components, solvent cements or thread pastes (if applicable), elastomeric seals, all valve components and lubricants. Testing under field conditions may be the best way to ensure selected materials will work in a particular application.

Kynar® is a registered trademark of Arkema Inc.
Corzan® is a registered trademark of The Lubrizol Corporation.

		Polyvinyl Chloride (PVC) 	Chlorinated Polyvinyl Chloride (Corzan® CPVC) 
Typical Applications		Chemical processing, industrial plating, chilled water distribution, chemical drainage, and irrigation systems	Systems for hot corrosive liquids, hot and cold water distribution, chemical processing, industrial plating, deionized water lines, chemical drainage, waste water treatment systems, and similar applications above the temperature range of PVC
Joining Methods		Solvent cementing, threading, or flanging	Solvent cementing, threading, or flanging
Max. Service Temperature		140° F/60° C	200° F/93° C
Fittings	Schedule 80	Socket– 1/2" through 12" Threaded– 1/4" through 4"	Socket– 1/4" through 12" Threaded– 1/4" through 4"
	Large diameter	10" and 12" couplings, tees, 90° and 45° elbows, reducer bushings, and Van Stone flanges	10" and 12" couplings, tees, 90° and 45° elbows, reducer bushings
Valves	Tru-Bloc®/True Union ball valves*	1/2" through 6" socket, threaded, and flanged connections	1/2" through 6" socket, threaded, and flanged connections
	Tru-Bloc®/True Union ball check valves	1/2" through 4" with socket, threaded, or flanged ends	1/2" through 4" with socket, threaded, or flanged ends
	Butterfly valves*	EPDM and FKM liner	EPDM and FKM liner 3" only
	Multiport valves*	True Union 3-way/3-position; 1/2" through 2" with socket, threaded, or flanged ends	True Union 3-way/3-position; 1/2" through 2" with socket, threaded, or flanged ends
	Specialty valves	Angle and Y pattern: 1/4" through 1" threaded Needle and Chemcock®: 1/4" threaded	
Pipe			

*For pneumatic or electric actuation.

Refer to Chemtrol Technical Manuals for pressure ratings at various temperatures.

Polypropylene
(PP)



Polyvinylidene Fluoride
(KYNAR® PVDF)



<p>Black Polypropylene: Clean chemical processes, hot corrosive liquids, industrial plating, waste treatment systems</p>	<p>Natural Polypropylene: Deionized water systems, clean chemical processes, pharmaceutical operations, food processing</p>	<p>Red KYNAR® PVDF, which protects fluid medium from UV exposure, is an excellent material for general industrial applications, especially outdoor installations.</p>	<p>Natural KYNAR® (Unpigmented) PVDF is ideal for industries such as electronics, pharmaceuticals, and processed foods or beverages.</p>
<p>Thermo-seal fusion, threading, or flanging</p>	<p>Thermo-seal fusion, threading, or flanging</p>	<p>Socket heat fusion, threading, or flanging</p>	<p>Socket heat fusion, threading, or flanging</p>
<p>180° F/82° C</p>	<p>180° F/82° C</p>	<p>280° F/138° C</p>	<p>280° F/138° C</p>
<p>IPS socket type— 1/2" through 6" Threaded— 1/2" through 4"</p>	<p>Socket ends— 1/2" through 4" Threaded— 1/2" through 4"</p>	<p>IPS socket type— 1/2" through 6" Threaded— 1/2" through 2"</p>	<p>IPS socket type— 1/2" through 6" Threaded— 1/2" through 2"</p>
<p>1/2" through 4" with socket, threaded, or flanged ends</p>	<p>1/2" through 4" with socket ends</p>	<p>1/2" through 4" with socket, threaded, or flanged ends</p>	<p>1/2" through 4" with socket, threaded, or flanged ends</p>
<p>1/2" through 4" with socket, threaded, or flanged ends</p>		<p>1/2" through 4" with socket, threaded, or flanged ends</p>	<p>1/2" through 4" with socket, threaded, or flanged ends</p>
	<p>1/2" through 4" with metric spigot, IPS socket, or ANSI flanged ends.</p>		<p>1/2" through 4" with metric spigot, IPS socket, or ANSI flanged ends.</p>
<p>Schedule 40 and 80 wall thicknesses</p>		<p>Schedule 80 wall thicknesses</p>	

Kynar® is a registered trademark of Arkema Inc.

Key to Chemtrol Valve Figure Number System

X XX XX - X - XX - SIZE

① ② ③ ④ ⑤ ⑥

① End Configurations

- S Socket
- F Flanged
- T Threaded (female)
- M Threaded (male)
- A Hose x Male Threaded
- W Wafer Style Butterfly
- U Universal (socket and threaded)

② Body Material

- 45 PVC Schedule 80
- 51 CPVC Schedule 80
- 61 Black Polypropylene (PP)
- 62 Chem-Pure® Natural Polypropylene (PP)
- 65 Red Kynar® PVDF
- 66 Natural Kynar® PVDF

③ Types of Valves

- AC Angle
- BC Ball Check
- BF Butterfly (Model B)
- BG Butterfly (Model C)
- CC Chemcock®
- CN Needle
- D2 Diverter (3-Way, 2-Position)
- FV Ball Foot
- M3 Multiport (3-Way, 3 Position)
- TB Tru-Bloc® True Union Ball Valve
- YP Y-Pattern

④ O-Ring Material

- E EPDM
- V FKM

⑤ Operating Mechanisms

- NO None
- LH Lever Handle, Manual
- RH Round Safety Handle, Manual
- GO Gear Operator, Manual

⑥ Size

State Valve Size

PVC and CPVC Tru-Bloc® True Union Ball Valve, Model D

Construction Materials

Components ¹	PVC	CPVC
1. Handle	Orange PVC	
2. Stem	PVC	CPVC
3. Body	PVC	CPVC
4. Seat-Carrier	PVC	CPVC
6. Union Nut	PVC	CPVC
7. End Connector	PVC	CPVC
8. Ball	PVC	CPVC
9. Seat ² ; (2 ea.)	PTFE	
10. O-Ring ³ – Seat-Carrier; End Seal	FKM or EPDM	
11. O-Ring ³ – Body; End Seal		
12. O-Ring ³ – Stem; OD Seal		
13. O-Ring ³ – Seat-Carrier; OD Seal		
14. O-Ring ³ – Seat-Carrier; Seat Energizer		
15. Plain-End Nipple; 2 ea. Spg x Spg	PVC	CPVC
16. Flange – 2 ea. Socket-End	PVC	CPVC
17. Stem; Friction Washer (4" & 6" Only)	PTFE	
18. Handle Bolt (4" & 6" Only)	PVC	

1 All components **except valve bodies** are available as replacement parts.

2 Each replacement **PTFE seat kit** contains two seats.

3 Each replacement O-ring kit contains all the O-rings required to refurbish a particular size True Union Ball or Check Valve (regardless of model or style), or a minimum of two pipe unions.

Chemtrol Figure Number

Valve Style	Elasto-meric Trim	PVC			CPVC		
		Soc.	Thd.	Flgd.	Soc.	Thd.	Flgd.
TU/TB	FKM	U45TB-V*	U45TB-V*	F45TB-V	U51TB-V*	U51TB-V*	F51TB-V
	EPDM	U45TB-E*	U45TB-E*	F45TB-E	U51TB-E*	U51TB-E*	F51TB-E

* As original equipment, 1/2" - 2" True Union Tru-Bloc valve models are supplied with universal connectors (i.e., a set of both socket and thread end connectors).

Dimensions—Weights—Flow Coefficients

Valve Size	TU Figures Profile					TU Figures End-to-End					Fluid Flow Coefficient		
	A ¹	B	C	D	K Flgd.	E Soc.	F Thd.	G Soc.	H Thd.	J Flgd.	PVC Approx. ² Wt. Lbs.	CPVC Approx. ² Wt. Lbs.	C _v ³ TU
1/2	2.07	2.16	1.82	.50	3.50	4.20	4.10	2.42	2.44	6.30	0.350	0.370	6.4
3/4	2.74	2.90	2.36	.75	3.88	5.02	4.62	3.02	3.05	7.34	0.690	0.730	38.7
1	2.74	3.07	2.73	1.00	4.26	5.47	5.32	3.22	3.40	8.17	0.960	1.000	58.2
1 1/4	2.62	3.91	4.07	1.25	4.62	6.53	6.07	4.01	4.06	9.41	2.155	2.255	61.7
1 1/2	2.62	3.91	4.07	1.50	5.00	6.89	6.23	4.10	4.18	10.05	2.190	2.315	117.4
2	3.12	4.71	5.23	2.00	6.00	8.04	7.39	5.01	5.19	11.44	4.410	4.670	178.4

1 Handle is not symmetrical about centerline. Dimensions shown represent the longest operational radius. The handle position is correctly shown for the 1/2" - 3" True Union valve style.

2 Weight for 1/2" - 2" TU figures includes both sets of end connectors.

3 C_v values computed for basic valve laying lengths (G).

Features

- Rated at 250 psi with non-shock water service at 73°F
- Corzan® HP CPVC rated at 130 psi at 180°F, see chart in Reference Data section for maximum service temperature.
- Retains laying length of previous models, full interchangeable cartridge, nuts and end connectors
- Designed, with an energizer O-ring beneath the PTFE seat, Model D and C valves automatically adjust for seat wear.
- Full-port design produces minimum flow restriction with the lowest possible pressure-drop
- Improved union nut grip style and flats on end connectors
- Universal product includes socket and threaded end connections
- Ergonomic handle with built-in carrier wrench
- Valves are manufactured and assembled without exposure to silicone compounds. Silicone-free lubricant is used to assemble all ball valves.

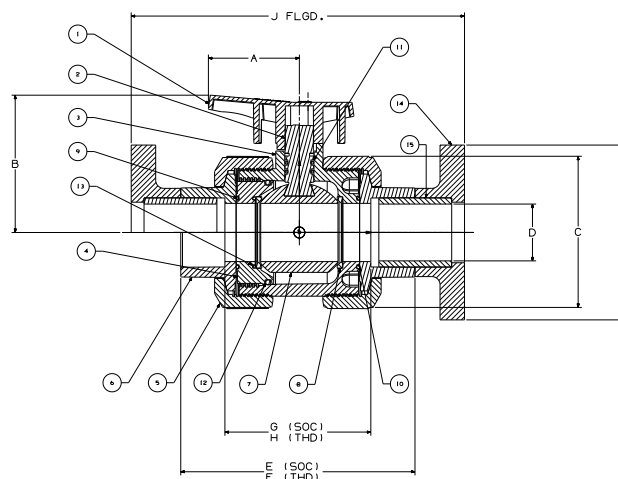

PVC and CPVC Tru-Bloc® True Union Ball Valve, Model C

Construction Materials

Components ¹	PVC	CPVC
1. Handle	Orange PVC	
2. Stem	PVC	CPVC
3. Body	PVC	CPVC
4. Seat-Carrier	PVC	CPVC
6. Union Nut	PVC	CPVC
7. End Connector	PVC	CPVC
8. Ball	PVC	CPVC
9. Seat ² ; (2 ea.)	PTFE	
10. O-Ring ³ – Seat-Carrier; End Seal	FKM or EPDM	
11. O-Ring ³ – Body; End Seal		
12. O-Ring ³ – Stem; OD Seal		
13. O-Ring ³ – Seat-Carrier; OD Seal		
14. O-Ring ³ – Seat-Carrier; Seat Energizer		
15. Plain-End Nipple; 2 ea. Spg x Spg	PVC	CPVC
16. Flange – 2 ea. Socket-End	PVC	CPVC
17. Stem; Friction Washer (4" & 6" Only)	PTFE	
18. Handle Bolt (4" & 6" Only)	PVC	

- 1 All components **except valve bodies** are available as replacement parts.
 2 Each replacement **PTFE seat kit** contains two seats.
 3 Each replacement O-ring kit contains all the O-rings required to refurbish a particular size True Union Ball or Check Valve (regardless of model or style), or a minimum of two pipe unions.

Features

- Rated at 150 psi with non-shock water service at 73°F.
- Designed with an energizer O-ring beneath the PTFE seat, Model D and C valves automatically adjust for seat wear.
- Full-port design produces minimum flow restriction with the lowest possible pressure-drop. 6" ball valve is reduced port.
- Valves are manufactured and assembled without exposure to silicone compounds. Silicone-free lubricant is used to assemble all ball valves.

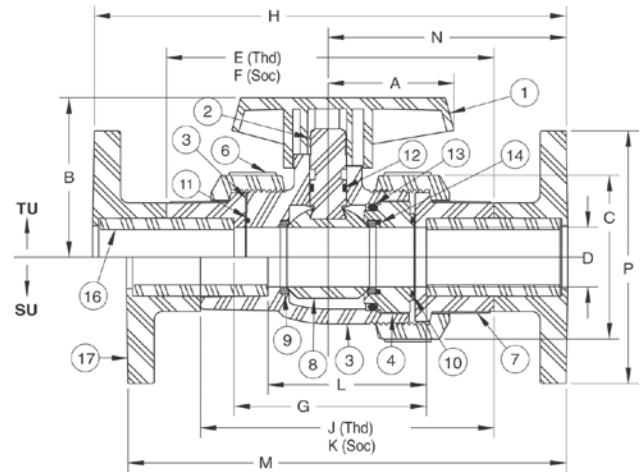

Chemtrol Figure Number

Valve Style	Elasto-meric Trim	PVC			CPVC		
		Soc.	Thd.*	Flgd.	Soc.	Thd.*	Flgd.
TU/TB	FKM	S45TB-V	T45TB-V	F45TB-V	S51TB-V	T51TB-V	F51TB-V
	EPDM	S45TB-E	T45TB-E	F45TB-E	S51TB-E	T51TB-E	F51TB-E

* Thread end connections are not available for 6" valves.

Dimensions—Weights—Flow Coefficients

Valve Size	TU Figures Profile						TU Figures End-to-End (3" thru 6")					Fluid Flow Coefficient C_v^3 TU
	A ¹	B	C	D	N	P	E Thd.	F Soc.	G Soc.	H Flgd.	Approx. ² Wt. Lbs.	
3	4.00	5.59	7.18	3.00	7.42	7.50	10.39	10.39	6.58	14.63	11.25	1348
4	8.00	6.05	8.78	4.00	8.52	9.00	12.22	12.22	7.66	17.63	17.68	2602
6 ⁴	8.00	6.05	8.78	4.00	11.90	11.05	NA	30.22	24.16	24.08	29.25	2602

- 1 Handle is not symmetrical about center line. Dimensions shown represent the longest operational radius. The handle position is correctly shown for the 3" True Union valve style, but the position must be rotated 180° from that shown for the 4" - 6" True Unions.
 2 Weight includes socket end connections only for 3" - 6" sizes. The material represented is PVC in all cases.
 3 C_v values computed for basic valve laying lengths (G).
 4 The 6" ball valve is a Venturi design derived from the 4" valve: a 4" end connector and a 6" coupling are connected by a 6" x 4" Venturied reducer, with a union nut captured within the assembly. Threaded end connection not available.

PVC and CPVC Tru-Bloc® True Union Vented (Bleach) Ball Valve, Model D

The Problem

Sodium hypochlorite, used in water treatment, aquatic centers, and paper and textile applications, can become trapped in the body cavity of a closed ball valve and create conditions that may result in damage to the valve or system as a result of unstable chemical decomposition.

The Chemtrol Solution

The Vented Ball Valve is a special factory modification to a PVC or CPVC True Union Ball Valve that effectively vents sodium hypochlorite out-gassing to the pressure port. In addition, the inner valve surfaces are kept constantly wetted to ensure problem-free use of the ball valves in bleach transfer and injection applications.

Background

In the search for a safer alternative to chlorine vacuum gas injection, fresh and wastewater treatment, paper and textile plants, and aquatic centers are converting to the use of sodium hypochlorite as a disinfectant or bleaching agent. A high pH level characterizes commercial bleach, which consists of a nominal 15% solution of sodium hypochlorite along with approximately 1-2% of sodium hydroxide to act as a chemical stabilizer. Known as a good oxidizer, the solution has been found to cause stress cracking in polyethylene and polypropylene materials. And metallic materials react, causing rapid decomposition of the "hypo." However, PVC and CPVC, with fluorocarbon rubber (FKM) seals, have been successfully used for years to handle this aggressive chemical solution.

Some system design considerations are important, though. Heat, time, and positive ions are enemies of bleach stability. When a ball valve is closed in periods of inactivity, the bleach will decompose over time liberating oxygen gas. The decomposition rate is increased by heat absorbed from sun shining on exposed piping, or by reaction heat resulting from debris trapped in a ball valve body between the ball and its seats. Gas pressure may slowly build in the closed valve cavity, or quite rapidly in the reactive case. Such conditions may result in damage to the valve or system.

Also, evaporation of sodium hypochlorite in the ball cavity can lead to the formation of crystalline residue that eventually embeds in the PTFE seats of a ball valve and significantly raises the turning torque due to excessive wear on the ball by fouled seats. Such conditions may result in a broken valve stem, frozen valve ball, or other damage to the valve or system.

The Chemtrol® Vented Ball Valve offers a viable solution for sodium hypochlorite transfer and injection applications. Our unique factory-assembled bleach ball valve has effectively eliminated the problems associated with these uses. By ensuring that all inner surfaces of the valve are kept constantly wetted and vented to the upstream side when the valve is in the closed position, we have eliminated the conditions required for gas accumulation and caustic crystallization in the body cavity.

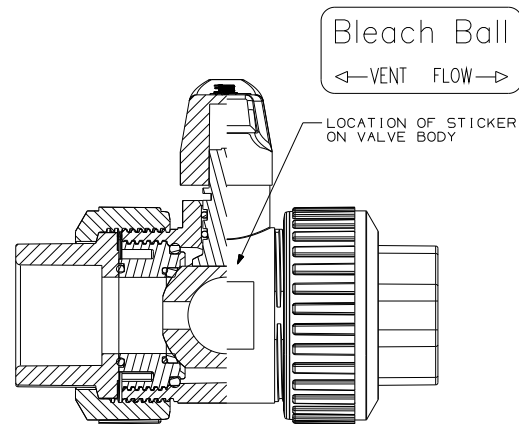
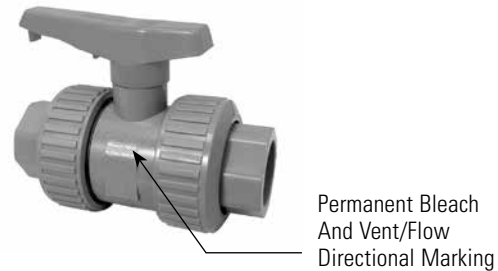

PVC and CPVC 3-Way, 3-Position (Multiport) True Union Ball Valve, Model A

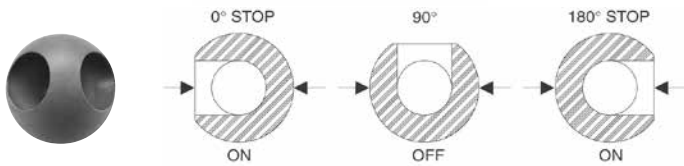

Features

- Rated at 150 psi with non-shock water service at 73°F
- For applications where flow direction and on-off control are needed
- Flow may be directed from the branch center-inlet to one side run-outlet (at the 0° stop position), then to shut-off (at the 90° position), and then to the opposite side run-outlet (at the 180° stop position).
- Flow may be directed from either of the side run-inlet ports to the branch center-outlet port, with shut-off at the mid position (when handle is perpendicular to the body). Cross-contamination of the two inlet streams is prevented at all intermediate positions between the 180° stops.
- **ADJ** externally molded onto the body to indicate the seat carrier end of the valve. Adjustment of this union nut can compensate for wear of PTFE seats, with no production loss to remove valve for internal adjustment.
- Valves are manufactured and assembled without exposure to silicone compounds. Silicone-free lubricant is used to assemble all ball valves.
- Full port design produces minimum flow restriction with the lowest possible pressure drop for 90° porting.

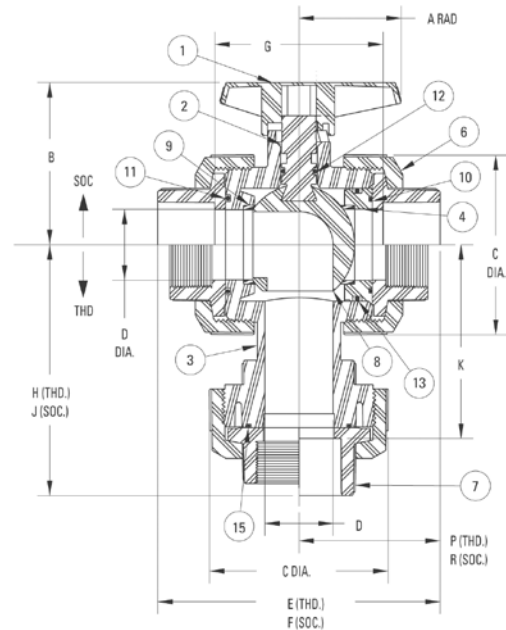

Construction Materials

Components ¹	PVC	CPVC
1. Handle		
2. Stem	PVC	CPVC
3. Body	PVC	CPVC
4. Seat-Carrier	PVC	CPVC
6. Union Nut	PVC	CPVC
7. End Connector	PVC	CPVC
8. Ball	PVC	CPVC
9. Seat ² ; (2 ea.)	PTFE	
10. O-Ring ³ – Seat-Carrier; End Seal		
11. O-Ring ³ – Body; End Seal		
12. O-Ring ³ – Stem; OD Seal	FKM or EPDM	
13. O-Ring ³ – Seat-Carrier; OD Seal		
14. O-Ring ³ – Branch Union; End Seal	FKM or EPDM	

- 1 All components except valve bodies are available as replacement parts.
 2 Each replacement PTFE seat kit contains two seats.
 3 Each replacement O-ring kit contains all the O-rings required to refurbish a particular size True Union Ball or Check Valve (regardless of model or style), or a minimum of two pipe unions.

Chemtrol Figure Numbers

Valve Style	Elastomeric Trim	PVC Soc.	Thd.	CPVC Soc.	Thd.
1/2" – 2" Multiport (3-Way/3-Position)	FKM	S45M3-V	T45M3-V	S51M3-V	T51M3-V
	EPDM	S45M3-E	T45M3-E	S51M3-E	T51M3-E

Dimensions–Weights–Flow Coefficients

Valve Size	Soc. & Thd Figures				Socket Figures				Threaded Figures				Fluid Flow Coefficient C _v ³		
	A ¹	B	C	D	F	G	J	K	R	E	H	P		Approx. ² Wt. Lbs.	
1/2	2.07	1.94	2.00	0.50	4.19	2.41	3.56	2.69	2.13	0.64	4.00	3.50	2.06	0.60	8
3/4	2.74	2.50	2.44	0.75	5.00	2.97	4.19	3.19	2.50	1.15	4.63	4.00	2.31	1.05	19
1	2.74	2.69	2.86	1.00	5.50	3.22	4.63	3.50	2.75	1.59	5.18	4.44	2.63	1.50	36
1 1/4	2.62	3.74	4.08	1.25	6.47	3.94	5.88	4.63	3.25	3.43	6.10	5.63	3.06	3.24	55
1 1/2	2.62	3.74	4.08	1.25	6.76	3.98	6.00	4.63	3.38	3.62	6.15	5.63	3.06	3.37	55
2	3.12	4.25	5.25	2.00	8.01	4.98	7.08	5.63	3.96	7.02	7.35	6.81	3.62	6.25	149

- 1 Handle is not symmetrical about stem centerline. Dimension shown represents the longest operational radius.
 2 Weights shown for socket figures are CPVC models. Weights for threaded figures are PVC models.

3 C_v values were computed using equivalent cylinder length for 90° turn with full bore.

* 1 1/2" valve has conventional port on center outlet.

PVC and CPVC 3-Way, 2-Position (Diverter) True Union Ball Valve, Model A

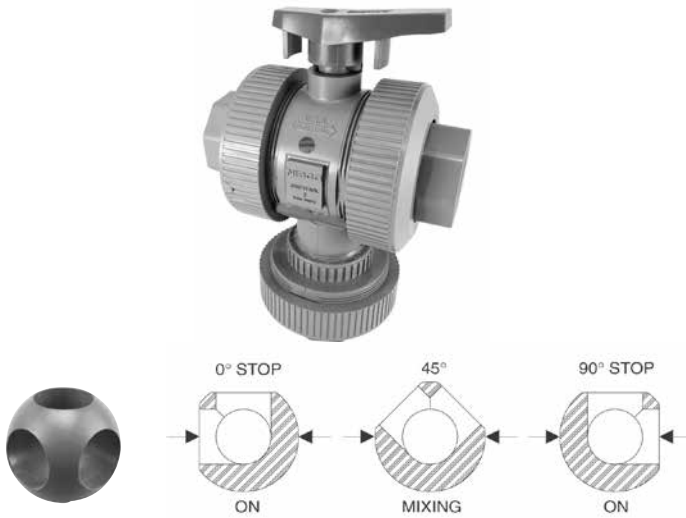

Features

- Rated at 150 psi with non-shock water service at 73°F
- For applications where a quarter-turn will achieve diversion of flow, but shut-off control is not required
- Flow may be diverted from the branch center-inlet to one side run-outlet (at the 0° stop position), and then to the opposite side run-outlet (at the 90° stop position)
- Flow may be diverted from either of the side run-inlet ports to the branch center-inlet port
- The internal porting of the diverter makes no provision for shut-off. Therefore, the valve can be used for proportional mixing at all intermediate positions between the 90° stops.
- **ADJ** externally molded onto the body to indicate the seat carrier end of the valve. Adjustment of this union nut can compensate for wear of PTFE seats, with no production loss to remove valve for internal adjustment.
- Valves are manufactured and assembled without exposure to silicone compounds. Silicone-free lubricant is used to assemble all ball valves.
- Full port design produces minimum flow restriction with the lowest possible pressure drop for 90° porting.

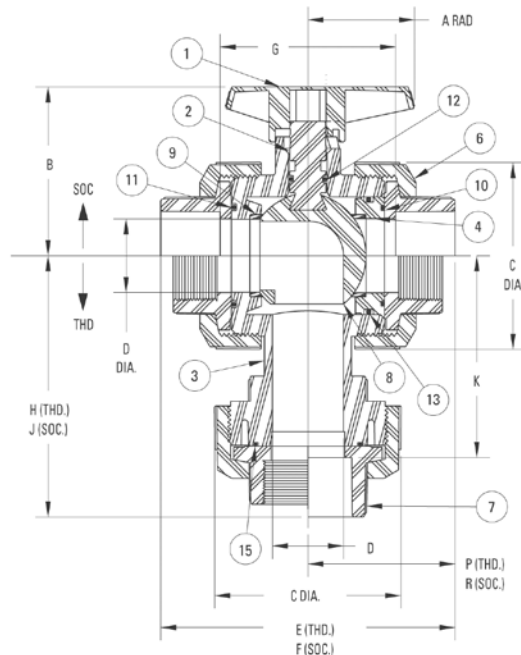

Construction Materials

Components ¹	PVC	CPVC
1. Handle – Lever		
2. Stem	PVC	CPVC
3. Body	PVC	CPVC
4. Seat-Carrier	PVC	CPVC
6. Union Nut	PVC	CPVC
7. End Connector	PVC	CPVC
8. Ball	PVC	CPVC
9. Seat ² ; (2 ea.)	PTFE	
10. O-Ring ³ – Seat-Carrier; End Seal		
11. O-Ring ³ – Body; End Seal		
12. O-Ring ³ – Stem; OD Seal	FKM or EPDM	
13. O-Ring ³ – Seat-Carrier; OD Seal		
14. O-Ring ³ – Branch Union; End Seal	FKM or EPDM	

- 1 All components except valve bodies are available as replacement parts.
 2 Each replacement PTFE seat kit contains two seats.
 3 Each replacement O-ring kit contains all the O-rings required to refurbish a particular size True Union Ball or Check Valve (regardless of model or style), or a minimum of two pipe unions.
 4 The two-piece seat-carrier assembly for Model B Tru-Bloc Valves was replaced by a one-piece carrier in Model C Tru-Bloc® Valves.

Chemtrol Figure Numbers

Valve Style	Elastomeric Trim	PVC Soc.	Thd.	CPVC Soc.	Thd.
1/2" – 2" Diverter (3-Way/2-Position)	FKM	S45D2-V	T45D2-V	S51D2-V	T51D2-V
	EPDM	S45D2-E	T45D2-E	S51D2-E	T51D2-E

Dimensions–Weights–Flow Coefficients

Valve Size	Soc. & Thd Figures		Socket Figures				Threaded Figures			Approx. ² Wt. Lbs.		Approx. ² Wt. Lbs.		Fluid Flow Coefficient C _v ³	
	A ¹	B	C	D	F	G	J	K	R	E	H	P			
1/2	2.07	1.94	2.00	0.50	4.19	2.41	3.56	2.69	2.13	0.64	4.00	3.50	2.06	0.60	8
3/4	2.74	2.50	2.44	0.75	5.00	2.97	4.19	3.19	2.50	1.15	4.63	4.00	2.31	1.05	19
1	2.74	2.69	2.86	1.00	5.50	3.22	4.63	3.50	2.75	1.59	5.18	4.44	2.63	1.50	36
1 1/4	2.62	3.74	4.08	1.25	6.47	3.94	5.88	4.63	3.25	3.43	6.10	5.63	3.06	3.24	55
1 1/2	2.62	3.74	4.08	1.25	6.76	3.98	6.00	4.63	3.38	3.62	6.15	5.63	3.06	3.37	55
2	3.12	4.25	5.25	2.00	8.01	4.98	7.08	5.63	3.96	7.02	7.35	6.81	3.62	6.25	149

- 1 Handle is not symmetrical about stem centerline. Dimension shown represents the longest operational radius.
 2 Weights shown for socket figures are CPVC models. Weights for threaded figures are PVC models.

3 C_v values were computed using equivalent cylinder length for 90° turn with full bore.

* 1 1/2" valve has conventional port on center outlet.

PVC Compact Economy Ball Valve

150 psi at 73°F water–non-shock



Features

- For water distribution in industrial, residential, commercial and agricultural applications.
- Multiple industrial uses
- Durable one-piece molded body
- Excellent flow characteristics
- Socket and threaded end connections per ASTM D2467 for Schedule 80 PVC pipe fittings
- NPT threads per ANSI B1.20.1
- Rated for 150 psi water service at 73°F and 50 psi service at 140°F
- Convenient 1/4 turn operation
- Meets NSF/ANSI 14 standard

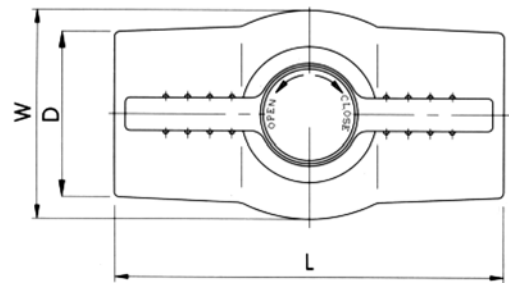
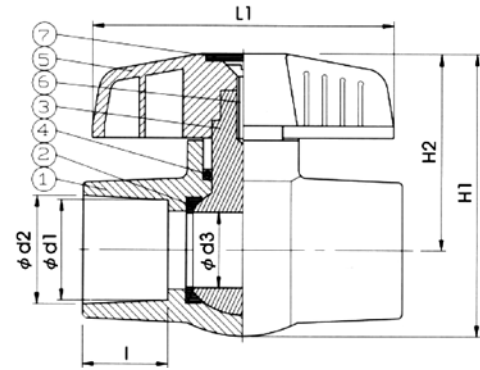

Construction Materials

Part	Specification
1. Body	PVC
2. Seat Seal (2)	PTFE
3. Ball	PVC
4. O-Ring	EPDM, FKM
5. Handle	ABS
6. Bolt	Zinc-Plated Steel
7. Cap	ABS

Chemtrol Figure Numbers

Material	O-Rings	Ends	(1/2" - 2")
PVC	EPDM	Soc.	S45CE-E
PVC	EPDM	Thd.	T45CE-E
PVC	FKM	Soc.	S45CE-V
PVC	FKM	Thd.	T45CE-E

DIMENSIONS—WEIGHTS—QUANTITIES

Size													Fluid Flow Coefficient	
In.	mm	Thd./In. (NPT)	d1	d2	d3	D	L	L1	l	H1	H2	W	Weight/lbs.	Cv
1/2	15	14	0.84	0.85	0.55	1.18	3.27	2.76	0.87	2.44	1.69	1.50	0.18	8.84
3/4	20	14	1.05	1.06	0.79	1.50	3.74	3.46	1.00	3.07	2.13	1.93	0.18	—
1	25	11.5	1.31	1.32	0.98	1.77	4.17	3.94	1.12	3.66	2.56	2.24	0.49	25.24
1 1/4	32	11.5	1.65	1.67	1.18	2.13	4.48	3.94	1.25	3.86	2.64	2.48	0.64	38.53
1 1/2	40	11.5	1.89	1.91	1.42	2.44	5.12	4.29	1.38	4.53	3.07	2.95	0.94	51.28
2	50	11.5	2.39	2.39	1.83	3.03	5.79	5.28	1.50	5.31	3.50	3.62	1.50	96.67

PVC Butterfly Valves, Model C

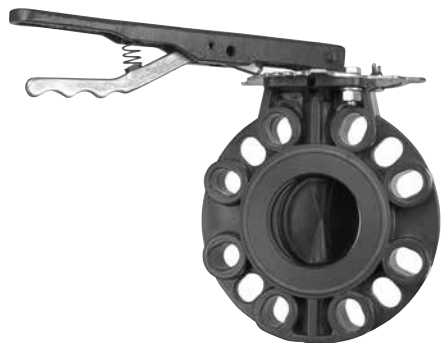

Features

- Rated at 150 psi with non-shock service at 73°F
- Available currently as a one-piece molded PVC body with EPDM trim the Model C Butterfly Valve is intended for general water applications and has also been successfully used to handle mild acidic solutions and medium concentrations of alkaline solutions
- Bolt hole pattern compatible with Class 150 ASME B16.5; BS 1560 class 150; DN 200 ISO 2084 PN 10; and DN 200 DIN 2532 PN 10
- Glass-filled PTFE bearing-bushings, extending almost the entire lengths of the upper and lower stems, transfer the hydraulic side load on the disk and evenly distributes it to the valve body to ensure low bearing stress with long, trouble-free operation.
- Rigid brass disk is encapsulated with EPDM, which is compressed to create the sealing mechanism for this butterfly valve.
- Built-in O-ring face-seals require no gaskets between mating flanges.
- A hole in the lever handle provides a blockage point for trigger lock operation, thus, locking the valve in the off position or any of the 9 increments of opening (10° each).
- This valve should not be used in aquatic center recirculation lines or water lines receiving chlorine gas or bleach injection
- Black graphite and fluorocarbon lubricant is used to assemble Model C butterfly valves.

Construction Materials

Part	Material
1. Upper Stem	416 Stainless Steel
2. Upper Bushing	Glass-Filled PTFE
3. O-Ring Stem Seal (2 required)	EPDM – Upper and Lower Stem
4. Body	PVC
5. Disk	EPDM Encapsulated Ductile Iron
6. Lower Bushing	Glass-Filled PTFE
7. Lower Stem	416 Stainless Steel
8. Plug	LDPE (Polyethylene)
9. O-Ring Face-Seal (2 required)	EPDM
10. Snap Ring (2 required)	Zinc Plated Steel
11. Lever Handle Assembly	
Handle w/Lever Lock	Malleable Iron
Throttling Plate	Zinc Plated Steel
Position Lock	Zinc Plated Steel

C_v Table

Size	Degrees Open								
	10°	20°	30°	40°	50°	60°	70°	80°	90°
2	2.5	8	18	33	50	73	100	131	166
2 1/2	3.7	12	27	49	74	109	148	195	247
3	4.3	16	35	62	94	135	180	235	290
4	8.6	34	76	137	215	310	420	550	690
6	17.5	67	200	265	410	580	790	1040	1340
8	20.8	83	190	320	530	770	1060	1380	1780
10	50.0	195	430	775	1200	1775	2700	3100	4000

Dimensions–Weights

Valve Size	A	B	C	D	E	F	G	H	I	J	K	L	M	Handle N	P	Approx. ¹ Wt./Lbs.
2	1.94	1.69	6.41	1.25	3.94	3.29	3.25	2.75	0.44	3.26	0.37	0.50	10.50	1.01	6.19	2.02
2 1/2	2.44	1.81	7.19	1.25	4.13	3.63	3.25	2.75	0.44	3.26	0.37	0.50	10.50	1.01	6.19	2.56
3	2.87	1.81	7.75	1.15	4.43	3.91	3.25	2.75	0.44	3.26	0.37	0.50	10.50	1.01	6.19	2.92
4	3.82	2.06	9.08	1.25	5.31	4.57	3.25	2.75	0.44	3.26	0.50	0.65	10.50	1.01	6.19	5.04
6	5.76	2.20	11.22	1.25	7.09	5.64	3.25	2.75	0.44	3.26	0.56	0.78	13.75	1.01	6.19	8.99
8	7.74	2.36	13.66	1.25	8.00	6.83	3.25	2.75	0.44	3.26	0.56	0.78	13.75	1.01	6.19	14.27
10	9.57	2.68	16.49	1.25	9.84	8.40	5.00	4.01	0.56	4.76	0.74	1.06	13.75	1.01	6.19	27.70

1 Operator not included in weight.

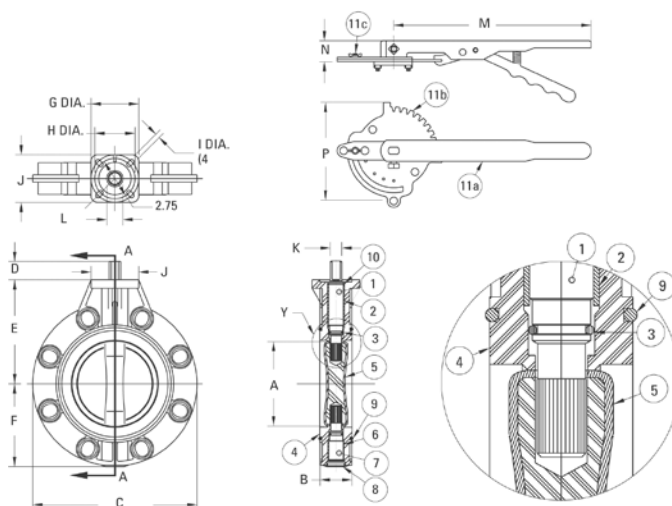

Chemtrol Figure Numbers

Disk Material	Operating Mechanism	2" – 10" Figure No. ¹
EPDM	Lever Handle ²	W45BG-E-3
	Gear Operator	W45BG-E-5

¹ 10" is available with gear operator only.

² Includes throttle plate and lock.

CPVC and PVC Butterfly Valves, Model B



Section A-A

Construction Materials

Part	Material
2. Top Bearing	Glass-Filled PTFE
3. O-Ring Seal (4 required)	FKM or EPDM
4. Disk/Stem	PVC ¹ w/ 316 Stainless Hex Shaft Insert-Molded
5. Body (2 required – mirror image)	3" - CPVC ¹ ; 4" & 6" - PVC
6. Seat/Boot	FKM or EPDM w/ GF-PTFE Upper & Lower Bearing-Bushings Insert-Molded
7. Cap Screws;	3" Valve (6) ea. 1/4"-20 x 7/8" Long Zinc Coated 4" Valve (6) ea. 5/16"-18 x 1" Long Zinc Coated 6" Valve (6) ea. 5/16"-18 x 1-1/2" Long & (2) ea. 5/16"-18 x 1" Long Zinc Coated
8. Hex Nuts;	3" Valve (6) ea. 1/4"-20 Zinc Coated 4" Valve (6) ea. 5/16"-18 Zinc Coated 6" Valve (8) ea. 5/16"-18 Zinc Coated
9. Lever Handle Assembly	
Handle w/Lever Lock	Malleable Iron
Throttling Plate	Zinc Plated Steel
Position Lock	Zinc Plated Steel

¹ Body, disk/stem, and throttle plate for 3" size are available in CPVC only.

C_v Table

Size	Degrees Open								
	10°	20°	30°	40°	50°	60°	70°	80°	90°
3	4.3	16	35	62	94	135	180	235	290
4	8.6	34	76	137	215	310	420	550	690
6	17.5	67	200	265	410	580	790	1040	1340

Model-B Butterfly Valve Dimensions–Weights

Valve Size	A	B	C	D	E	J	G	H	R	Handle			Approx. ¹ Wt./Lbs.
										M	N	P	
3	4.75	1.26	7.00	3.06	8.50	2.00	3.62	3.38	.37	10.50	1.01	6.19	3.25
4	6.13	1.22	9.00	4.00	10.63	2.22	3.62	3.38	.50	10.50	1.01	6.19	6.00
6	7.50	1.62	11.00	5.97	13.00	2.77	3.76	3.50	.56	13.75	1.01	6.19	12.00

¹ Operator not included in weight.

Features

- Rated at 150 psi with non-shock service at 73°F (6" size 115 psi)
- Mates between ASME B16.5, Class 150; ISO 2084 PN 10, DN 80; and DIN 2532, PN 10, DN 80. Both 4-bolt and 8-bolt patterns are in 3" size.
- PVC overmolded 316 stainless hex shaft not exposed to the liquid
- Top bearing, as well as the upper and lower bushings, are glass-filled PTFE for ease of operation and maximum service life.
- Seat/boot design eliminates need for gaskets between mating flanges.
- Silicone-free lubricant is used to assemble Model B butterfly valves.

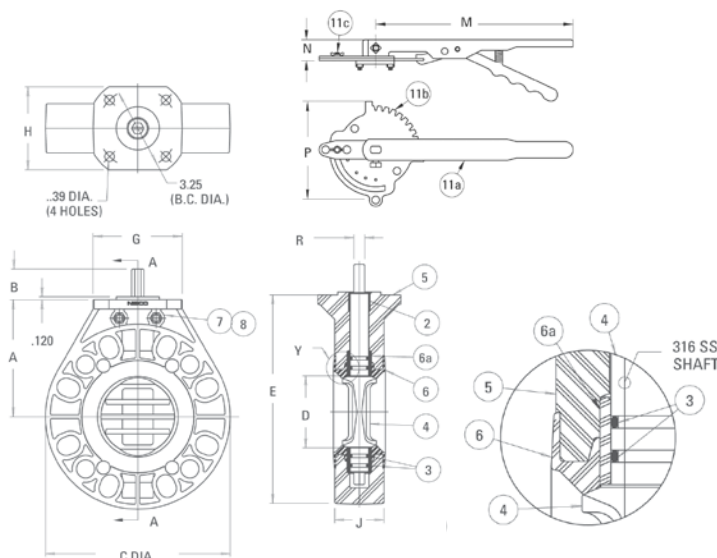

Chemtrol Figure Numbers

Seat Material	Operating Mechanism	3" (CPVC) ²	4" (PVC)	6" (PVC)
		Figure No.	Figure No.	Figure No.
EPDM	No Operator	W51BF-E-NO	W45BF-E-NO	W45BF-E-NO
	With Lever ¹ Handle	W51BF-E-LH	W45BF-E-LH	W45BF-E-LH
	With Gear Operator	NA	W45BF-E-GO	W45BF-E-GO
FKM ¹	No Operator	W51BF-V-NO	W45BF-V-NO	W45BF-V-NO
	With Lever ¹ Handle	W51BF-V-LH	W45BF-V-LH	W45BF-V-LH
	With Gear Operator	NA	W45BF-V-GO	W45BF-V-GO

¹ Includes throttle plate and hardware.

² Body and disk/stem for 3" size are available in CPVC only.

PVC and CPVC True Union Ball Check, Foot, and Vent Valves

Chemtrol Figure Numbers

Type Valve	End Conn	Elastomeric Trim	Materials	
Ball Check Valve			PVC	CPVC
	Soc.	FKM EPDM	U45BC-V ¹ U45BC-E ¹	U51BC-V ¹ U51BC-E ¹
	Thd.	FKM EPDM	U45BC-V ¹ U45BC-E ¹	U51BC-V ¹ U51BC-E ¹
	Flgd.	FKM EPDM	F45BC-V F45BC-E	F51BC-V F51BC-E

¹ 1/2"-2" PVC and CPVC TU ball check figures are supplied with universal connection components (i.e., a set of both socket and threaded end connectors). For 3" and 4" sizes of PVC and CPVC BC valves, replace U in the figure no. with S or T for socket or threaded units respectively.

Features

- Rated at 150 psi with non-shock service at 73°F.
- Gravity ball check may be converted for air or gas venting by replacement of standard ball with natural polypropylene floater ball. Then install valve upside down for fluid to lift ball into seat.
- For foot valve, replace inlet end connection with a foot valve screen housing assembly.
- Free oscillation of ball in guide ribs facilitates full port flow with minimum turbulence and chatter.
- Equally effective in checking back flows from head pressure on the discharge or suction sides of pump.



Construction Materials

Components ¹	PVC	CPVC
1. Union Nut	PVC	CPVC
2. End Connector	PVC	CPVC
3. Ball	PVC	CPVC
– Standard for Check or Foot Valve	Natural PP Floater Ball	
4. Body ¹	PVC	CPVC
– Floater Ball for Vent Valve ²		
5. C.V. Seat-Carrier	PVC	CPVC
6. O-ring ³ Body & Carrier; End Seal	FKM or EPDM	
7. O-ring ³ Seat-Carrier, OD Seal	FKM or EPDM	
8. O-ring ³ Seat Seal	FKM or EPDM	
9. Plain End Pipe Nipple for Flanged Valve	PVC	CPVC
10. Flange-Socket for Flanged Valve	PVC	CPVC
11. Foot Valve Screen Housing Assembly ⁴	PVC	CPVC

¹ All components except valve bodies are available as replacement parts.

² Gravity ball check valves are converted to vent valves by replacing the standard ball with a floater ball and inverting the valve at installation—with seat up.

³ Each replacement O-ring kit contains all the O-rings required to refurbish any True Union Check or Ball Valve (regardless of model or style), or a minimum of two pipe unions.

⁴ Gravity ball check valves are converted to foot valves by replacing the union nut and end connector on the receiving end – seat end – of the body with an F.V. screen housing assembly.

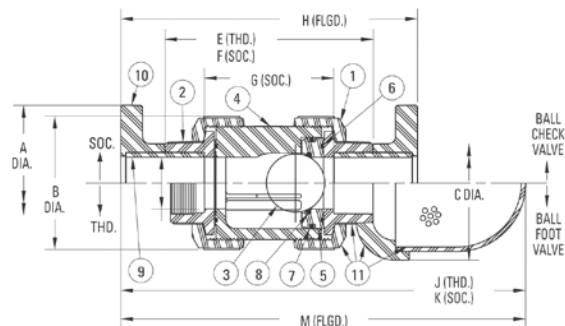

Dimensions¹—Weights³—Fluid Flow Coefficients

Valve Size	Ball Check/Foot				Ball Check Valve					Ball Foot Valve				Seating Head Ft – H ₂ O		Fluid Flow Coefficient
	A	B	C	D	E Thd.	F Soc.	G Soc.	H Flgd.	Approx. ² Wt. Lbs.	J Thd.	K Soc.	M Flgd.	Approx. ³ Wt. Lbs.	Vert.	Horiz.	C _v ³
1/2	3.50	1.98	2.63	0.50	3.94	4.13	2.36	6.27	0.42	6.13	6.19	7.25	0.23	6	7	5
3/4	3.88	2.44	2.63	0.75	4.65	5.02	3.00	7.38	0.72	6.88	7.13	8.25	0.29	6	7	10
1	4.26	2.83	3.63	1.00	5.08	5.40	3.12	7.99	1.05	8.13	8.25	9.63	0.37	4	5	19
1 1/4	4.62	4.08	5.50	1.25	6.38	6.75	4.22	9.65	2.46	11.13	11.25	12.75	1.34	4	5	37
1 1/2	5.00	4.08	5.50	1.50	6.38	6.99	4.21	10.18	2.62	11.13	11.50	13.13	1.34	4	5	56
2	6.00	5.23	5.50	2.00	7.36	8.02	4.99	11.45	4.76	11.75	12.13	13.75	1.88	4	5	101
3	7.50	7.17	5.50	3.00	9.98	9.98	6.17	14.22	9.21	13.38	13.38	15.63	3.00	3	4	251
4 ⁴	9.00	7.17	5.50	3.00	20.76	20.76	16.20	16.14	14.18	18.50	18.50	16.25	3.00	3	4	251

¹ Foot valve screen housing assemblies are available for the field conversion of PVC and CPVC TU ball check valves in sizes 1/2" - 4".

² Weights shown for ball valve figures are PVC threaded models. For an approximation of CPVC check valve weights, the PVC weight may be multiplied by factor of 1.123. Weights shown for foot valves are actually those for PVC F.V. screen housing assemblies. So, the weight for a CPVC F.V. screen housing assy. may be found by multiplying the PVC weight by the 1.123 factor. These must be added to check valve weight for full foot valve weight.

³ C_v values are based on the basic valve laying length (G).

⁴ The 4" PVC and CPVC check valves are fabricated by solvent cementing either reducing flanges or reducing couplings onto the ends of a 3" valve with plain-end nipples.

PVC Angle and Y-Pattern Globe Valves



Chemtrol Figure No.
T45AC-V



Chemtrol Figure No.
T45AC-V

Both styles available with threaded end connections only.

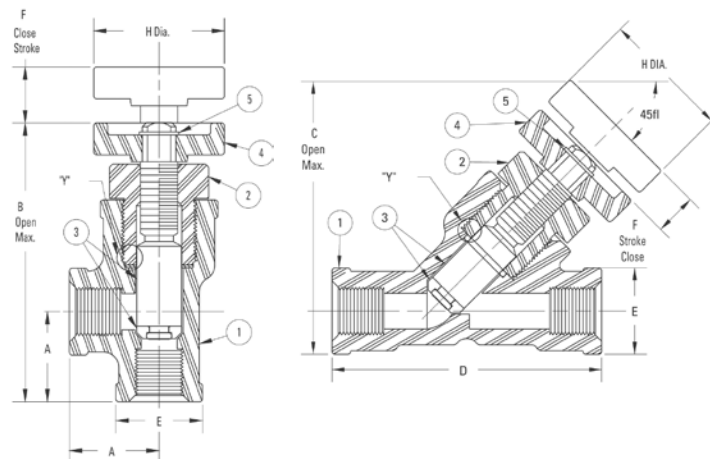

Features

- Rated at 150 psi with non-shock service at 73°F
- Y-pattern style has a minimal pressure-drop when compared with a conventional upright style globe valve
- Malleable glass reinforced PTFE seat disk ensures long-lasting positive sealing.
- Stub acme thread on stem provides rapid open-close operation.
- Liquid or slurry never touches stem threads.
- Can be used for both on-off and throttling control of fluid flow.
- Easy in-line maintenance.

Construction Materials

Part	Material
1. Body – Angle	PVC
– or Y-Pattern	PVC
2. Bonnet	PVC
3. Stem Assembly	PVC w/ Glass Filled PTFE Seat Disk
4. Handle	PVC
5. Snap Ring Retainer	Zinc Plated Steel
6. O-Ring – Body Seal	FKM
7. Energizer Back-Up Washer ¹	PVC
8. CV Stem Seal (2 required) ¹	PTFE
9. O-Ring – Stem Seal Energizer ¹	FKM

¹ Items not required for 1/4" valve.

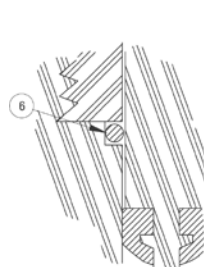

Detail "Y" Enlarged View
1/4" Size Valve

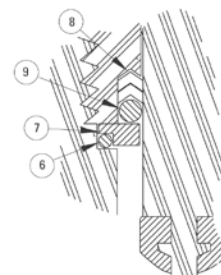

Detail "Y" Enlarged View
1/2" & 3/4" Size Valve

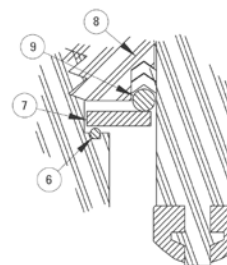

Detail "Y" Enlarged View
1" Size Valve

Valve Dimensions – Weights – Flow Coefficients

Valve Size	Common Dimensions			Angle Valve ¹				Y-Pattern Valve ¹			
	Hub Dia. E	Close Stroke F	Handle Dia. H	Center-To-Face A	Open Max. B	Flow Coef. C _v ²	Approx. Weight Lbs.	End-To-End D	Open Max. C	Flow Coef. C _v ²	Approx. Weight Lbs.
1/4	0.88	.44	1.32	0.88	3.56	1.1	0.11	2.75	2.75	3.1	0.12
1/2	1.25	.75	2.19	1.31	5.38	5.4	0.28	3.50	4.63	17.7	0.30
3/4	1.50	.94	2.19	1.41	6.50	9.9	0.47	4.25	5.56	32.5	0.53
1	1.75	1.19	2.19	1.88	7.88	15.8	0.69	5.00	6.31	49.3	0.73

¹ Available with threaded end connections only.

² C_v measured with valves completely open.

PVC Chemcock® and Calibrated Needle Lab Valves



Chemtrol Figure No.

A45CC-V	1/4" Hose x 1/4" MPT
M45CC-V	1/4" MPT x 1/4" MPT

Features

- Rated at 150 psi with non-shock service at 73°F
- Its (4.8) calculated fluid flow coefficient (Cv) is based on the laying length being equivalent to 1/4" Schedule 80 pipe.
- Easily adaptable to any type of connection.
- Opens and closes with only a quarter turn.
- Replaceable FKM O-ring seats and seals.
- Corrosion-resistant all thermoplastic PVC construction.
- No sticking or galling.
- Full port design.

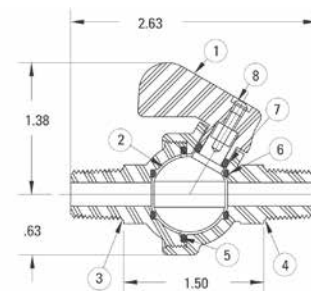
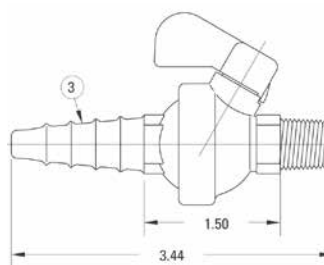

Approx. Weight 0.06 lbs.

Construction Materials

Part	Material
1. Handle	PVC
2. Ball/Stem	PVC
3. Body End – Hose or Thread	PVC
4. Body Half – Stem Side	PVC
5. O-Ring – Body Seal	FKM
6. O-Ring – Ball Seats (2)	FKM
7. O-Ring – Stem Seal	FKM
8. Handle Screw	Cadmium Plated Steel



Chemtrol Figure No.

T45CN-V	1/4" FPT x 1/4" FPT
---------	---------------------

Features

- Rated at 150 psi with non-shock service at 73°F
- Precise flow measurement.
- Positive stop for safe operation.
- PTFE seat prevents wear on needle.
- Accurately adjust the flow by observing the knob handle exposing numerals molded on the valve body

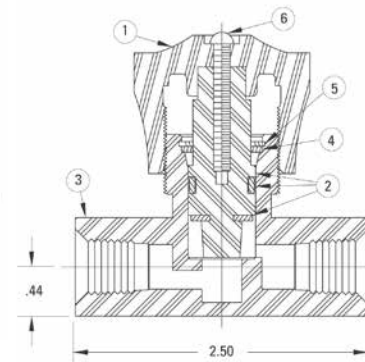
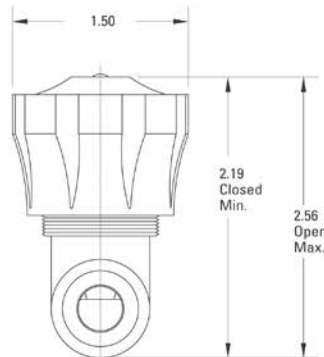

Approx. Weight 0.13 lbs.

Construction Materials

Part	Material
1. Adjustment Knob	PVC
2. Stem Assembly	PVC w/PTFE Seat Seal & FKM Stem Seal
3. Body	PVC
4. Retainer Washer	PVC
5. Snap Ring	Stainless Steel
6. Screw	Stainless Steel

Knob Position	GPM @ Constant 50 PSI
8	.85
7	1.41
6	1.79
5	2.15
4	2.42
3	3.15
2	4.40
1	4.50

Alternative Manual Operators

Part Numbers For Alternative Manual Operators

Accessory	Use	Valve Size								
		1/2	3/4 & 1	1 1/4 & 1 1/2	2	2 1/2	3	4	6	8
2" Sq. Nut Stem Adapter	PVC for TB Ball Valves	21630007	21630009	21630011	21630012	—	21630014	21630016	21630016	—
	PVC for HV Ball Valves	21630007	21630009	21630011	21630011	—	—	—	—	—
Round Safety Handle	PVC for TB Ball Valves	81616007	81616009	81621011	81621012	—	—	—	—	—
	PVC for HV Ball Valves	81616007	81616009	81621011	81621011	—	—	—	—	—

2" Square Nut Stem Adapter—Permits operation of a valve with a standard utility (AWWA) wrench. The most common application is for valves located in an underground valve box. The square nut for ball valves is made from PVC. It snaps onto the stem and locks into the slot for turning-stops of a ball valve of any material, in place of its standard handle.



Round Safety Handle—Design prevents accidental operation of low-torque ball valve by snagging the lever handle with personal clothing or equipment. Suitable for PVC and CPVC Tru-Bloc® True Union Ball Valves, Model D.



Standoff Stem Extensions for Ball Valves—Provide handle clearance, with the integrity of turning-stops, for insulating, panel-mounting, or shallow submerged applications. These extensions are made of solid PVC, and are short; so top support is not required. Although priced in increments of 1" standoff, between handle and stem, they can be supplied in exact lengths if specified when ordered. And, if the extension is to be installed on a valve of material other than PVC or CPVC, that must also be specified when ordering.



PVC Standoff Stem Extensions For Ball Valve

Length Of Ext.	Valve Size					
	1/2	3/4 & 1	1 1/4 & 1 1/2	2	3	4 & 6
1" Long	21618007	21618009	—	—	—	—
2" Long	21617150	21617175	21617214	21617226	21617069	21617076
3" Long	21617151	21617177	21617216	21617229	21617249	21617078
4" Long	21617153	21617179	21617218	21617231	21617251	21617257
5" Long	21617155	21617181	21617220	21617228	21617299	21617298
6" Long	21617157	21617183	21617222	21617235	21617252	21617260

Valve Lockout Devices

Part Numbers for Valve Lockout Devices

Type Lockout Device	Location Mounted	Valve Size										
		1/2	3/4	1	1 1/4	1 1/2	2	2 1/2	3	4	6	8
BV Handle and Locking Ring Kit	Field	81644007	81644008	81644009	81644011	81644011	81644012	—	—	—	—	—
PP Lockout Cover for Ball Valve	Field	70060210	70060210	70060210	70060211	70060211	70060211	—	70060212	—	—	—
Ball Valve-Mounted Lockout Kit W/ Std. Plastic Handle	Field	70050007	70050008	70050009	70050011	70050011	70050012	—	70050014	70050016	70050016	—
	Factory	70050107	70050108	70050109	70050111	70050111	70050112	—	70050114	70050116	70050116	—
Ball Valve-Mounted Lockout Kit W/ Lever Handle and Index Plate	Field	70080007	70080008	70080009	70080011	70080011	70080012	—	70080014	70080016	70080016	—
	Factory	70080107	70080108	70080109	70080111	70080111	70080112	—	70080114	70080116	70080116	—

Meet OSHA Standard 29 CFR 1910.147; The Control of Hazardous Energy (Lockout/ Tagout). The range in complexity and cost of these devices generally reflects the various usage requirements of frequency, permanency, and multiples of function. The gang hasp, for multi-discipline locking, is shown for the purpose of illustration only. It is not available with any of the devices.

TB Ball Valve Handle and Locking Ring Kit

The locking ring surrounds the valve handle for permanent attachment to the valve. When the lock device is removed from the handle and retaining arm of the ring, the ring arm simply hangs beneath the valve. This single function kit is effective for valve-off lockout only or may be added to other Tru-Bloc® valves of any material.

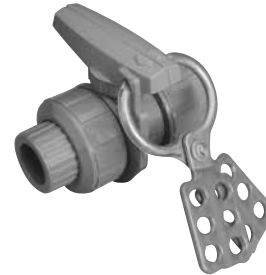

Ball Valve Lockout Cover

This two-piece molded polypropylene split clamshell closure, which is hinged to fasten around the common handles of Tru-Bloc valves, is a simple provision for maintenance or operations lockout. The cover can be locked with the handle in the on, off, or any throttling position, but when the cover is locked the handle position, relating ball posture, is not visible. One of three cover sizes is usually transported to the point of use, because a cover is not easily attached to the valve when it is unlocked.



TB Ball Valve-Mounted Lockout Kit w/Standard Plastic Handle

This all-plastic kit, permanently mounted on a valve, may be locked in the on or off valve position. Whether locked or unlocked, the distinguishing handle position is clearly visible at all times, including throttling postures.



TB Ball Valve-Mounted Lockout Kit w/ Lever Handle and Index Plate

This kit consists of a lever-lock handle and index plate, adapted to fit a ball valve mount. It provides for locking the valve in the off position or any of the 9 increments of opening (10° each), including the full on position. The handle position, aligned with the fully on ball posture, is visible at all times.

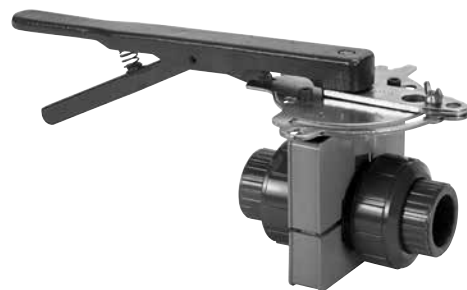

PVC Schedule 80

Couplings	24
Adapters	25
Elbows	26
Tees	27
Plugs	28
Caps	28
Bushings	29
Class 150 Flanges	30
Unions	32
Metal Transition Unions	33

Corzan® CPVC Schedule 80

Couplings	34
Adapters	35
Elbows	35
Tees	36
Plugs	37
Caps	38
Bushings	38
Class 150 Flanges	40
Unions	42

Fitting Terms and Abbreviations Schedule 80 only

FPT Female Pipe Thread
CL Close
MPT Male Pipe Thread
S Female Socket
SH Short
SPG Male End (Spigot)

Dimensions and Standards

Universal Part No.

XX XX - XXX

① ② ④

Chemtrol Part No.

(Discontinued)

XX XXX XXX

① ② ④

Material and Product Type

Product Line	① Universal Part Number	① Chemtrol Part Number	① Chemtrol Figure Number
PVC Sch. 80	8	01	45
CPVC Sch. 80	18	05	51
PP Black Sch. 80.	28	07	61
Sch. 80	78	10	62
PVDF Red Sch. 80	38	58	65
NPVDF Natural Sch. 80	48	06	66

Fitting Description

Fitting & End Connection	② Universal Part No.	② Chemtrol Part No.	② Chemtrol Fitting	③ Chemtrol Figure No. Connection(s)
Tee-Socket	01	013	00	Blank
Tee-Socket x Thread	02	015	12	Blank
Tee-Thread	05	014	12	3-3
90° ELL-Socket	06	001	07	Blank
90° ELL-Socket x Thread	07	003	07	3
90° ELL-Thread	08	002	07	3-3
90° Street ELL-Male Thread x Socket	10	219	07	4
90° Street ELL-Male Thread x Thread	12	213	07	3-4
45° ELL-Socket	17	007	06	Blank
45° ELL-Thread	19	008	06	3-3
Coupling-Socket	29	025	01	Blank
Coupling-Thread	30	026	01	3-3
Adapter Coupling-Socket x Thread	35	027	03	Blank
Male Adapter-Male Thread x Socket	36	217	04	Blank
Reducing Bushing-Socket	37	049	18	Blank
Reducing Bushing-Spigot x Thread	38	051	18	3
Reducing Bushing-Thread	39	050	18	3-4
Cap-Socket	47	031	17	Blank
Cap-Thread	48	032	17	3
Plug-Spigot	49	042	16	Blank
Plug-Thread	50	043	16	4
Flange-Socket	51	045	51	Blank
Flange-Thread	52	044	51	3
Flange-Blind	53	046	19	Blank
Van Stone Flange-Socket	54	069	51	A
Union-Socket	97	028	33	Blank
Union-Thread	98	029	33	3-3
Nipple-Thread x Thread	61	053	29	Blank

Chemtrol Figure

XX XX - X - X - SIZE

① ② ③ ④

Size Description	④ Universal Part Number	④ Chemtrol Part Number	④ Chemtrol Figure Number
Size			
1/4	002	004	↑
1/2	005	007	
3/4	007	008	
1	010	009	
1 1/4	012	010	
1 1/2	015	011	
2	020	012	
2 1/2	025	013	
3	030	014	
4	040	016	
6	060	018	Simply State Size
8	080	019	
10	100	020	
12	120	021	
1/2 x 1/4	072	027	
3/4 x 1/4	098	029	
3/4 x 1/2	101	031	
1 x 1/4	128	032	
1 x 1/2	130	034	
1 x 3/4	131	035	
1 1/4 x 1/2	166	038	↓
1 1/4 x 3/4	167	039	
1 1/4 x 1	168	040	
1 1/2 x 1/2	209	043	
1 1/2 x 3/4	210	044	
1 1/2 x 1	211	045	
1 1/2 x 1 1/4	212	046	
2 x 1/2	247	049	
2 x 3/4	248	050	
2 x 1	249	051	
2 x 1 1/4	250	052	
2 x 1 1/2	251	053	
2 1/2 x 1/2	287	056	
2 1/2 x 3/4	288	057	
2 1/2 x 1	289	058	
2 1/2 x 1 1/4	290	059	
2 1/2 x 1 1/2	291	060	
2 1/2 x 2	292	061	
3 x 1	335	066	
3 x 1 1/4	336	067	
3 x 1 1/2	337	068	
3 x 2	338	069	
3 x 2 1/2	339	069	
4 x 2	420	076	
4 x 2 1/2	421	077	
4 x 3	422	078	
6 x 2	528	082	
6 x 3	530	084	
6 x 4	532	085	
8 x 6	585	088	

Couplings

Chemtrol
Fig. No.

4501 Socket Coupling (S x S)

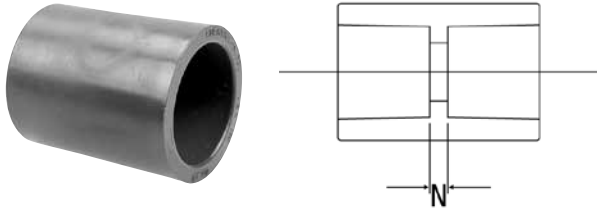

Nominal Size	Universal Part No.	Ctn. Qty.	Approx. Lbs./Ea.	Dim. N
1/4	829-002	25	0.05	0.12
1/2	829-005	50	0.09	0.25
3/4	829-007	50	0.13	0.25
1	829-010	40	0.14	0.25
1 1/4	829-012	25	0.22	0.25
1 1/2	829-015	20	0.29	0.25
2	829-020	25	0.42	0.25
2 1/2	829-025	5	0.68	0.20
3	829-030	12	1.05	0.19
4	829-040	10	1.83	0.19
6	829-060	4	3.56	0.25
8	829-080	2	8.69	0.25
10	829-100	1	13.88	0.38
12	829-120	1	22.69	0.50

4501-R Reducing Socket Coupling (S x S)

Nominal Size	Universal Part No.	Ctn. Qty.	Approx. Lbs./Ea.	Dim. N
3/4 x 1/2	829-101	25	0.12	0.44
1 x 1/2	829-130	25	0.18	0.67
1 x 3/4	829-131	25	0.19	0.55
1 1/4 x 3/4	829-167	25	0.26	0.72
1 1/4 x 1	829-168	10	0.27	0.60
1 1/2 x 1/2	829-209	10	0.31	0.81
1 1/2 x 3/4	829-210	10	0.31	0.76
1 1/2 x 1	829-211	10	0.33	0.63
1 1/2 x 1 1/4	829-212	10	0.35	0.51
2 x 1	829-249	10	0.44	0.75
2 x 1 1/2	829-251	10	0.50	0.50
3 x 2	829-338	5	1.00	1.24
4 x 2	829-420	5	1.59	1.59
4 x 3	829-422	5	1.88	1.20

Other Reducing Couplings are produced by solvent cementing appropriate Reducer Bushings into Socket Couplings. They may be ordered as factory fabrications or may be assembled in the field.

Chemtrol
Fig. No.

4501-3-3 Thread Coupling (FPT x FPT)

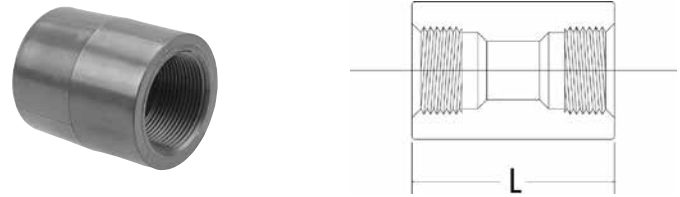

Nominal Size	Universal Part No.	Ctn. Qty.	Approx. Lbs./Ea.	Dim. L
1/4	830-002	25	0.06	1.41
1/2	830-005	25	0.09	2.03
3/4	830-007	25	0.14	2.28
1	830-010	25	0.23	2.53
1 1/4	830-012	10	0.33	2.78
1 1/2	830-015	10	0.41	3.03
2	830-020	10	0.60	3.28
2 1/2	830-025	5	0.86	3.76
3	830-030	5	1.22	4.00
4	830-040	5	2.13	4.75

4501-3-3-R Reducing Thread Coupling (FPT x FPT)

Nominal Size	Universal Part No.	Ctn. Qty.	Approx. Lbs./Ea.	Dim. L
3/4 x 1/2	830-101	25	0.14	2.34
1 x 1/2	830-130	25	0.20	2.70
1 x 3/4	830-131	25	0.18	2.70
1 1/4 x 3/4	830-167	10	0.29	3.00
1 1/4 x 1	830-168	10	0.31	3.00
1 1/2 x 3/4	830-210	10	0.35	3.16
1 1/2 x 1	830-211	10	0.38	3.16
1 1/2 x 1 1/4	830-212	10	0.40	3.16
2 x 1	830-249	10	0.50	3.40
2 x 1 1/2	830-251	10	0.56	3.40
3 x 2	830-338	5	1.15	4.66
4 x 2	830-420	5	1.79	5.38
4 x 3	830-422	5	2.11	5.38

Other Reducing Couplings are produced by solvent cementing appropriate Reducer Bushings into Socket Couplings. They may be ordered as factory fabrications or may be assembled in the field.

Adapters

Chemtrol
Fig. No.

4503 Female Adapter Coupling (S x FPT)

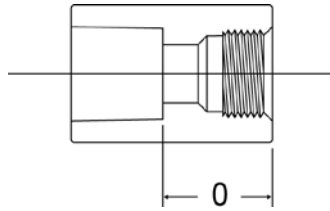

Nominal Size	Universal Part No.	Ctn. Qty.	Approx. Lbs./Ea.	Dim. O
1/4	835-002	15	0.04	0.77
1/2	835-005	25	0.09	1.14
3/4	835-007	25	0.14	1.27
1	835-010	20	0.21	1.39
1 1/4	835-012	10	0.30	1.52
1 1/2	835-015	10	0.38	1.64
2	835-020	10	0.56	1.77
2 1/2	835-025	5	0.77	1.98
3	835-030	5	1.15	2.10
4	835-040	5	1.95	2.47

4504 Male Adapter (S x MPT)

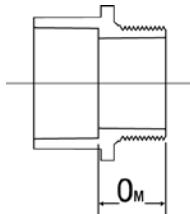

Nominal Size	Universal Part No.	Ctn. Qty.	Approx. Lbs./Ea.	Dim. O _M
1/2	836-005	25	0.04	0.94
3/4	836-007	25	0.06	0.97
1	836-010	25	0.10	1.15
1 1/4	836-012	10	0.14	1.12
1 1/2	836-015	10	0.19	1.12
2	836-020	10	0.27	1.20
2 1/2	836-025	5	0.50	1.89
3	836-030	5	0.79	1.99
4	836-040	5	1.30	2.09

Chemtrol
Fig. No.

4550 Tank Adapter (Tank x FPT)

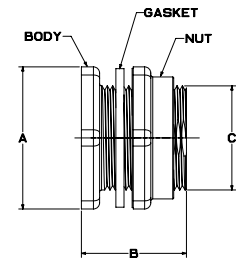

Nominal Size	Universal Part No.	Ctn. Qty.	Approx. Lbs./Ea.	Dim. A	Dim. B	Dim. C
1/2		15	0.20	2.00	2.75	1.38
3/4	Use	15	0.35	2.38	2.88	1.63
1	Figure	15	0.40	2.56	2.88	1.88
1 1/4	No. &	10	0.55	3.25	3.00	2.63
1 1/2	Nom.	10	0.65	3.25	3.00	2.63
2	Size	5	1.15	4.38	3.25	3.25
3		5	2.10	6.00	3.63	4.50

Note: Gasket is EPDM and nut is self-tightening left hand thread.

For complete technical information and more, refer to our website at www.chemtrol.com.

Elbows

Chemtrol
Fig. No.

4507 Socket 90° Elbow (S x S)

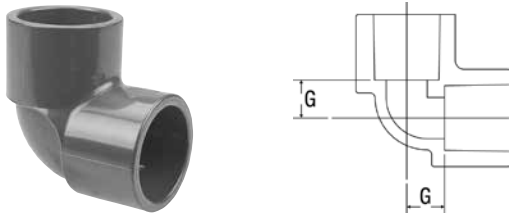

Nominal Size	Universal Part No.	Ctn. Qty.	Approx. Lbs./Ea.	Dim. G
1/4	806-002	25	0.01	0.33
1/2	806-005	50	0.11	0.52
3/4	806-007	50	0.16	0.69
1	806-010	50	0.21	0.75
1 1/4	806-012	25	0.25	0.92
1 1/2	806-015	25	0.38	1.06
2	806-020	25	0.57	1.27
2 1/2	806-025	5	1.16	1.53
3	806-030	12	1.50	1.84
4	806-040	12	3.08	2.34
6	806-060	4	8.03	3.50
8	806-080	2	15.25	4.56
10	806-100	1	27.70	5.75
12	806-120	1	43.90	6.89

4507-3 Socket x Thread 90° Elbow (S x FPT)

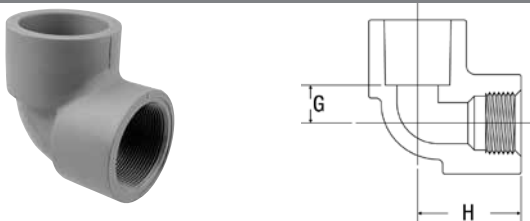

Nominal Size	Universal Part No.	Ctn. Qty.	Approx. Lbs./Ea.	Dim. G	Dim. H
1/2	807-005	10	0.12	0.52	1.41
3/4	807-007	10	0.17	0.69	1.71
1	807-010	10	0.28	0.75	1.89
1 1/4	807-012	10	0.33	0.92	2.18
1 1/2	807-015	10	0.55	1.06	2.45
2	807-020	10	0.82	1.27	2.78

4507-12/4506-12 Flanged ELLs

Flanged fitting center-to-face dimensions may be found on page 12. When ordering, specify the figure number and the nominal size (e.g., 2" Schedule 80 PVC flanged 90° Elbow-4507-12 2")

Chemtrol
Fig. No.

4507-3-3 Thread 90° Elbow (FPT x FPT)

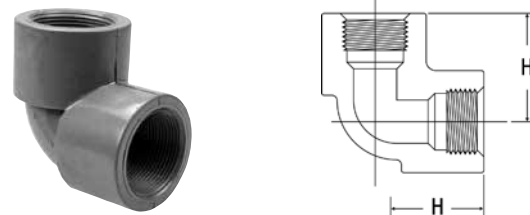

Nominal Size	Universal Part No.	Ctn. Qty.	Approx. Lbs./Ea.	Dim. H
1/4	808-002	25	0.04	0.97
1/2	808-005	25	0.12	1.41
3/4	808-007	25	0.18	1.71
1	808-010	25	0.28	1.89
1 1/4	808-012	10	0.42	2.18
1 1/2	808-015	10	0.55	2.45
2	808-020	10	0.82	2.78
2 1/2	808-025	5	1.25	3.31
3	808-030	5	1.90	3.74
4	808-040	5	3.62	4.62

4506 Socket 45° Elbow (S x S)

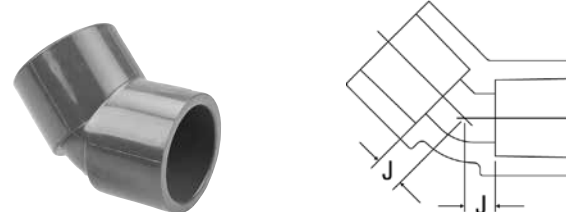

Nominal Size	Universal Part No.	Ctn. Qty.	Approx. Lbs./Ea.	Dim. J
1/4	817-002	15	0.03	0.18
1/2	817-005	25	0.04	0.26
3/4	817-007	25	0.14	0.33
1	817-010	25	0.15	0.37
1 1/4	817-012	10	0.24	0.43
1 1/2	817-015	10	0.31	0.47
2	817-020	10	0.48	0.61
2 1/2	817-025	5	0.93	0.68
3	817-030	6	1.23	0.78
4	817-040	6	2.46	1.02
6	817-060	4	6.21	1.75
8	817-080	2	13.03	2.22
10	817-100	1	19.70	2.61
12	817-120	1	32.70	3.08

Chemtrol
Fig. No.

4506-3-3 Thread 45° Elbow (FPT x FPT)

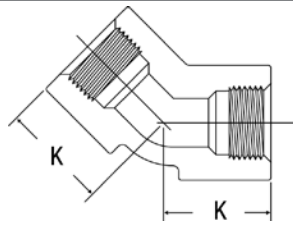

Nominal Size	Universal Part No.	Ctn. Qty.	Approx. Lbs./Ea.	Dim. K
1/4	819-002	15	0.04	0.82
1/2	819-005	25	0.11	1.15
3/4	819-007	25	0.13	1.35
1	819-010	25	0.25	1.51
1 1/4	819-012	10	0.35	1.70
1 1/2	819-015	10	0.48	1.86
2	819-020	10	0.71	2.13
2 1/2	819-025	5	1.03	2.46
3	819-030	6	1.53	2.69
4	819-040	6	2.52	3.30

Tees

4511 Socket Tee (S x S x S)

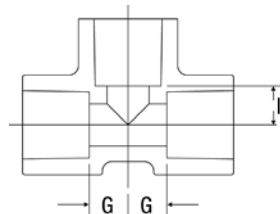

Nominal Size	Universal Part No.	Ctn. Qty.	Approx. Lbs./Ea.	Dim. G	Dim. G	Dim. I
1/4	801-002	25	0.05	0.33	0.33	0.33
1/2	801-005	50	0.11	0.52	0.52	0.52
3/4	801-007	50	0.17	0.69	0.69	0.69
1	801-810	25	0.25	0.75	0.75	0.75
1 1/4	801-012	10	0.48	0.92	0.92	0.92
1 1/2	801-015	10	0.52	1.06	1.06	1.06
2	801-020	20	0.97	1.27	1.27	1.27
2 1/2	801-025	5	1.50	1.53	1.53	1.53
3	801-030	12	2.00	1.84	1.84	1.84
4	801-040	10	3.54	2.34	2.34	2.34
6	801-060	4	10.47	3.50	3.50	3.50
8	801-080	1	20.57	4.56	4.56	4.56
10	801-100	1	35.40	5.75	5.75	5.75
12	801-120	1	58.40	6.89	6.89	6.89

Chemtrol
Fig. No.

4511-12 Flanged Tee

Flanged fitting center-to-face dimensions may be found on page 12. When ordering, specify the figure number and the nominal size (e.g., 2" Schedule 80 PVC flanged tee-4511-12 2")

4511-R Reducing Socket Tee (S x S x S)

Nominal Size	Universal Part No.	Ctn. Qty.	Approx. Lbs./Ea.	Dim. G	Dim. G	Dim. I
3/4 x 3/4 x 1/2	801-101	25	0.18	0.52	0.52	0.62
1 x 1 x 1/2	801-130	10	0.24	0.53	0.53	0.73
1 x 1 x 3/4	801-131	10	0.26	0.63	0.63	0.74
1 1/2 x 1 1/2 x 3/4	801-210	10	0.48	0.67	0.67	1.05
1 1/2 x 1 1/2 x 1	801-211	10	0.52	0.77	0.77	1.04
2 x 2 x 1/2	801-247	10	0.61	0.61	0.61	1.30
2 x 2 x 3/4	801-248	10	0.65	0.71	0.71	1.30
2 x 2 x 1	801-249	10	0.69	0.81	0.81	1.30
2 x 2 x 1 1/2	801-251	10	0.83	1.08	1.08	1.30
3 x 3 x 2	801-338	5	1.73	1.37	1.37	1.86
4 x 4 x 2	801-420	5	2.79	1.42	1.42	2.36
4 x 4 x 3	801-422	5	3.33	1.90	1.90	2.38
6 x 6 x 4	801-532	4	7.29	2.60	2.60	3.56

4512 Socket x Thread Tee (S x S x FPT)

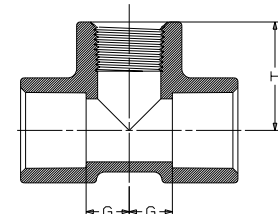

Nominal Size	Universal Part No.	Ctn. Qty.	Approx. Lbs./Ea.	Dim. G	Dim. G	Dim. H
1/2	802-005	10	0.16	0.52	0.52	1.41
3/4	802-007	10	0.24	0.69	0.69	1.71
1	802-010	10	0.34	0.75	0.75	1.89
1 1/4	802-012	10	0.57	0.92	0.92	2.18
1 1/2	802-015	10	0.80	1.06	1.06	2.45
2	802-020	10	1.13	1.27	1.27	2.78

For questions concerning thermoplastic piping systems, please call or fax: **888.446.4226 (ph)**, **888.336.4226 (fx)**.

Chemtrol
Fig. No.

4512-3-3 Threaded Tee (FPT x FPT x FPT)

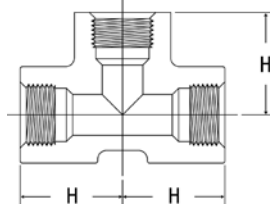

Nominal Size	Universal Part No.	Ctn. Qty.	Approx. Lbs./Ea.	Dim. H
1/4	805-002	25	0.05	0.97
1/2	805-005	25	0.16	1.41
3/4	805-007	25	0.26	1.71
1	805-010	25	0.35	1.89
1 1/4	805-012	10	0.57	2.18
1 1/2	805-015	10	0.75	2.45
2	805-020	10	1.13	2.78
2 1/2	805-025	5	1.79	3.31
3	805-030	5	2.60	3.74
4	805-040	5	4.63	4.62

Plugs

4516-4 Thread Plug (MPT)

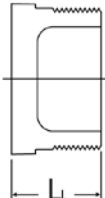

Nominal Size	Universal Part No.	Ctn. Qty.	Approx. Lbs./Ea.	Dim. L1
1/4	850-002	25	0.01	0.85
1/2	850-005	50	0.03	1.04
3/4	850-007	50	0.03	1.10
1	850-010	25	0.06	1.25
1 1/4	850-012	10	0.10	1.66
1 1/2	850-015	10	0.14	1.78
2	850-020	10	0.19	1.92
2 1/2	850-025	5	0.29	2.18
3	850-030	5	0.51	2.42
4	850-040	5	0.95	2.81

1/4" Plug is solid, only

Caps

Chemtrol
Fig. No.

4517 Socket Cap* (S)

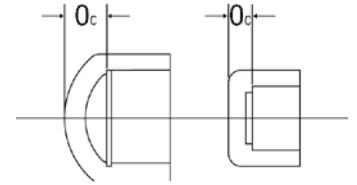

Nominal Size	Universal Part No.	Ctn. Qty.	Approx. Lbs./Ea.	Dim. Oc
1/4	847-002	15	0.03	0.25
1/2	847-005	25	0.06	0.39
3/4	847-007	25	0.08	0.37
1	847-010	25	0.14	0.41
1 1/4	847-012	10	0.20	0.40
1 1/2	847-015	10	0.26	0.41
2	847-020	10	0.38	0.42
2 1/2	847-025	5	0.57	0.57
3	847-030	5	0.87	1.29
4	847-040	5	1.53	1.58
6	847-060	5	3.77	2.13

*Sizes 2" and smaller are flat; 2 1/2" and larger are domed.

4517-3 Thread Cap* (FPT)

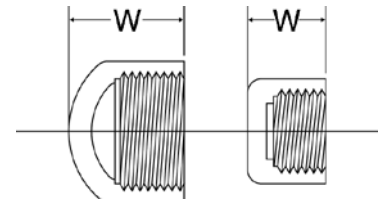

Nominal Size	Universal Part No.	Ctn. Qty.	Approx. Lbs./Ea.	Dim. W
1/4	848-002	15	0.01	0.89
1/2	848-005	25	0.06	1.28
3/4	848-007	25	0.10	1.38
1	848-010	25	0.15	1.55
1 1/4	848-012	10	0.22	1.66
1 1/2	848-015	10	0.29	1.80
2	848-020	10	0.41	1.93
2 1/2	848-025	5	0.64	2.35
3	848-030	5	0.93	3.19
4	848-040	5	1.73	3.86

*Sizes 2" and smaller are flat; 2 1/2" and larger are domed.

Bushings

Design Styles

The design style of most bushings is to have a solid wall between the inside and outside connections. Some of the multistep reductions with exceedingly thick cross-sections are not solid. This design style achieves structural support with a web of ribs attaching the inner and outer connection walls, with the open area toward the exterior bushing face. The styles are denoted by W and S for webbed and solid designs respectively.

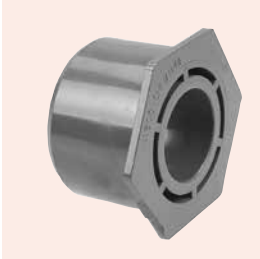

Webbed design

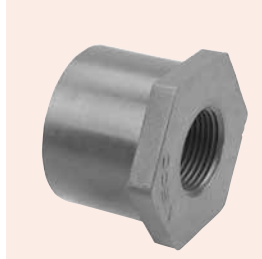

Solid design

Chemtrol
Fig. No.

4518 Flush Socket Reducer Bushing (SPG x S)

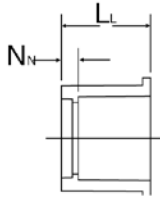

Nominal Size	Universal Part No.	Ctn. Qty.	Approx. Lbs./Ea.	Design Style	Dim. L _L	Dim. N _N
1/2 x 1/4	837-072	50	0.03	S	1.17	0.53
3/4 x 1/2	837-101	50	0.05	S	1.15	0.26
1 x 1/2	837-130	50	0.06	S	1.28	0.39
1 x 3/4	837-131	50	0.05	S	1.28	0.27
1 1/4 x 1/2	837-166	10	0.10	S	1.41	0.52
1 1/4 x 3/4	837-167	10	0.10	S	1.41	0.40
1 1/4 x 1	837-168	10	0.06	S	1.41	0.27
1 1/2 x 1/2	837-209	25	0.12	W	1.53	0.64
1 1/2 x 3/4	837-210	25	0.10	S	1.53	0.52
1 1/2 x 1	837-211	25	0.08	S	1.53	0.39
1 1/2 x 1 1/4	837-212	10	0.06	S	1.53	0.27
2 x 1/2	837-247	25	0.20	W	1.66	0.77
2 x 3/4	837-248	25	0.20	W	1.66	0.65
2 x 1	837-249	25	0.20	W	1.66	0.52
2 x 1 1/4	837-250	10	0.19	S	1.66	0.40
2 x 1 1/2	837-251	25	0.15	S	1.66	0.27
2 1/2 x 1	837-289	10	0.31	W	1.94	0.80
2 1/2 x 1 1/4	837-290	10	0.31	W	1.94	0.68
2 1/2 x 1 1/2	837-291	10	0.27	S	1.94	0.55
2 1/2 x 2	837-292	10	0.24	S	1.94	0.43
3 x 1	837-335	10	0.65	W	2.42	1.28
3 x 1 1/2	837-337	10	0.67	W	2.42	1.03
3 x 2	837-338	10	0.64	S	2.42	0.91
3 x 2 1/2	837-339	10	0.48	S	2.42	0.64

Chemtrol
Fig. No.

4518 Flush Socket Reducer Bushing (SPG x S) (cont.)

Nominal Size	Universal Part No.	Ctn. Qty.	Approx. Lbs./Ea.	Design Style	Dim. L _L	Dim. N _N
4 x 2	837-420	10	1.14	W	2.81	1.30
4 x 2 1/2	837-421	5	1.14	W	2.81	1.03
4 x 3	837-422	10	0.93	S	2.81	0.91
6 x 2	837-528	5	3.28	W	3.06	1.55
6 x 4	837-532	10	2.68	S	3.06	0.78
8 x 6	837-585	3	5.46	S	4.59	1.56
10 x 6	837-626	1	10.68	W	5.59	2.56
10 x 8	837-628	1	9.36	S	5.59	1.09
12 x 8	837-668	1	16.73	W	6.59	2.09
12 x 10	837-670	1	12.77	S	6.59	1.09

Other Reducing Couplings are produced by solvent cementing appropriate Reducer Bushings into Socket Couplings. They may be ordered as factory fabrications or may be assembled in the field.

4518-3 Flush Spigot x Thread Reducer Bushing (SPG x FPT)

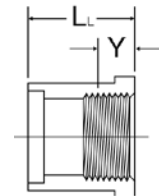

Nominal Size	Universal Part No.	Ctn. Qty.	Approx. Lbs./Ea.	Design Style	Dim. L _L	Dim. Y*
1/2 x 1/4	838-072	50	0.03	S	1.17	0.31
3/4 x 1/4	838-098	50	0.04	S	1.29	0.31
3/4 x 1/2	838-101	50	0.03	S	1.29	0.43
1 x 1/2	838-130	50	0.07	S	1.56	0.43
1 x 3/4	838-131	50	0.05	S	1.56	0.45
1 1/4 x 1/2	838-166	10	0.14	S	1.66	0.43
1 1/4 x 3/4	838-167	10	0.12	S	1.66	0.45
1 1/4 x 1	838-168	10	0.10	S	1.66	0.53
1 1/2 x 1/2	838-209	10	0.21	S	1.78	0.43
1 1/2 x 3/4	838-210	10	0.19	S	1.78	0.45
1 1/2 x 1	838-211	5	0.17	S	1.78	0.53
1 1/2 x 1 1/4	838-212	10	0.18	S	1.78	0.55
2 x 1/2	838-247	10	0.34	S	1.92	0.43
2 x 3/4	838-248	10	0.32	S	1.92	0.45
2 x 1	838-249	10	0.29	S	1.92	0.53
2 x 1 1/4	838-250	10	0.24	S	1.92	0.55
2 x 1 1/2	838-251	10	0.20	S	1.92	0.55
2 1/2 x 2	838-292	5	0.25	S	2.18	0.57
3 x 1	838-335	5	0.65	S	2.42	0.53
3 x 1 1/2	838-337	5	0.70	S	2.42	0.55
3 x 2	838-338	5	0.67	S	2.42	0.57
3 x 2 1/2	838-339	5	0.52	S	2.42	0.87
4 x 2	838-420	5	1.17	S	2.81	0.57
4 x 3	838-422	5	1.01	S	2.81	0.95

Other size reductions are produced by solvent cementing appropriate Reducer Bushings together. They may be ordered as factory fabrications or may be assembled in the field.

*Typical male component engagement, hand tight (L₁ in ANSI B1.20.1 thread spec.) plus 1 1/2 turns.

Chemtrol
Fig. No.

4518-3-4 Flush Thread Reducer Bushing (MPT x FPT)

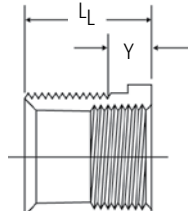

Nominal Size	Universal Part No.	Ctn. Qty.	Approx. Lbs./Ea.	Design Style	Dim. L _L	Dim. Y*
1/2 x 1/4	839-072	50	0.02	S	0.93	0.25
3/4 x 1/4	839-098	50	0.03	S	0.95	0.25
3/4 x 1/2	839-101	50	0.02	S	0.95	0.25
1 x 1/2	839-130	50	0.05	S	1.24	0.38
1 x 3/4	839-131	50	0.03	S	1.24	0.38
1 1/4 x 1/2	839-166	10	0.10	S	1.27	0.38
1 1/4 x 3/4	839-167	10	0.09	S	1.27	0.38
1 1/4 x 1	839-168	10	0.07	S	1.27	0.38
1 1/2 x 1/2	839-209	10	0.20	S	1.28	0.38
1 1/2 x 3/4	839-210	10	0.14	S	1.28	0.38
1 1/2 x 1	839-211	10	0.12	S	1.28	0.38
1 1/2 x 1 1/4	839-212	10	0.08	S	1.28	0.38
2 x 1/2	839-247	10	0.32	S	1.32	0.38
2 x 3/4	839-248	10	0.30	S	1.32	0.38
2 x 1	839-249	10	0.28	S	1.32	0.38
2 x 1 1/4	839-250	10	0.22	S	1.32	0.38
2 x 1 1/2	839-251	10	0.18	S	1.32	0.38
2 1/2 x 2	839-292	5	0.21	S	2.18	0.57
3 x 1 1/2	839-337	5	0.58	S	2.42	0.55
3 x 2	839-338	5	0.56	S	2.42	0.57
3 x 2 1/2	839-339	5	0.45	S	2.42	0.87
4 x 2	839-420	5	1.09	S	2.81	0.57
4 x 3	839-422	5	0.81	S	2.81	0.95

Other size reductions are produced by solvent cementing appropriate Reducer Bushings together. They may be ordered as factory fabrications or may be assembled in the field.

*Typical male component engagement, hand tight (L_L in ANSI B1.20.1 thread spec.) plus 1 1/2 turns.

Class 150 Flanges

For flange dimensions that comply with ANSI B16.5, 150 lb., steel flanges, see Reference Data on following pages.

Chemtrol
Fig. No.

4551-H Socket Flange (S), One-Piece (Solid)

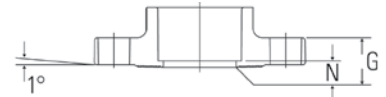

Nominal Size	Universal Part No.	Ctn. Qty.	Approx. Lbs./Ea.	Dim. G	Dim. N
1/2	851-H05	10	0.21	0.54	0.20
3/4	851-H07	10	0.31	0.61	0.17
1	851-H10	24	0.41	0.68	0.18
1 1/4	851-H12	10	0.53	0.73	0.20
1 1/2	851-H15	12	0.68	0.82	0.23
2	851-H20	12	0.96	0.92	0.27
2 1/2	851-H25	5	1.61	1.02	0.20
3	851-H30	10	2.16	1.13	0.29
4	851-H40	10	2.98	1.24	0.32
6	851-H60	5	4.44	1.36	0.31
8	851-H80	2	9.12	1.50	0.35

Reducing Flanges are produced by solvent cementing Reducer Bushings into Socket Flanges. They may be ordered as factory fabrications or may be assembled in the field.

4551-H-3 Thread Flange (FPT), One-Piece (Solid)

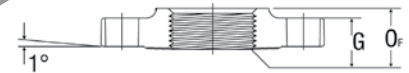
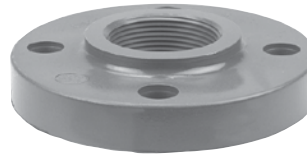

Nominal Size	Universal Part No.	Ctn. Qty.	Approx. Lbs./Ea.	Dim. G	Dim. O _F
1/2	852-H05	10	0.21	0.54	0.88
3/4	852-H07	10	0.30	0.61	0.91
1	852-H10	10	0.40	0.68	1.08
1 1/4	852-H12	10	0.50	0.73	1.11
1 1/2	852-H15	12	0.65	0.82	1.12
2	852-H20	10	0.90	0.92	1.18
2 1/2	852-H25	5	1.50	1.02	1.42
3	852-H30	5	1.93	1.13	1.55
4	852-H40	5	2.80	1.24	1.67

Reducing Flanges are produced by solvent cementing Reducer Bushings into Socket Flanges. They may be ordered as factory fabrications or may be assembled in the field.

Chemtrol
Fig. No.

4519-H Blind Flange, One-Piece (Solid)

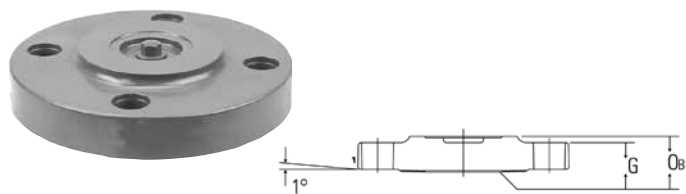

Nominal Size	Universal Part No.	Ctn. Qty.	Approx. Lbs./Ea.	Dim. G	Dim. O _B
1/2	853-H05	10	0.21	0.54	0.76
3/4	853-H07	10	0.32	0.61	0.83
1	853-H10	10	0.43	0.68	0.88
1 1/4	853-H12	10	0.57	0.73	0.95
1 1/2	853-H15	12	0.69	0.82	1.04
2	853-H20	12	1.08	0.92	1.13
2 1/2	853-H25	5	1.81	1.02	1.22
3	853-H30	10	2.45	1.13	1.39
4	853-H40	5	3.56	1.24	1.51
6	853-H60	5	5.97	1.36	1.60
8	853-H80	2	10.96	1.50	1.78

4551-W Socket Flange (S), One-Piece (Webbed Design)

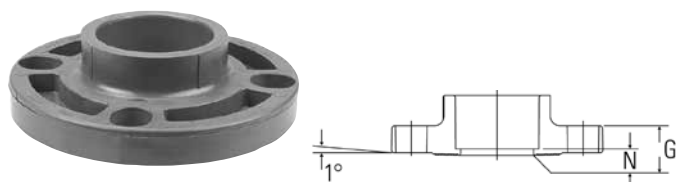

Nominal Size	Universal Part No.	Ctn. Qty.	Approx. Lbs./Ea.	Dim. G	Dim. N
2	851-020	12	0.79	0.92	0.27
3	851-030	10	1.52	1.13	0.29
4	851-040	10	2.25	1.24	0.32
6	851-060	5	4.24	1.36	0.31

Note: One-piece webbed flanges have oblong bolt holes which permit mating with ANSI B16.5, 150 lb.; BS 1560, class 150; ISO 2084, PN10; and DIN 2532, PN10 flanges.

4551-W-3 Thread Flange (FPT), One-Piece (Webbed Design)

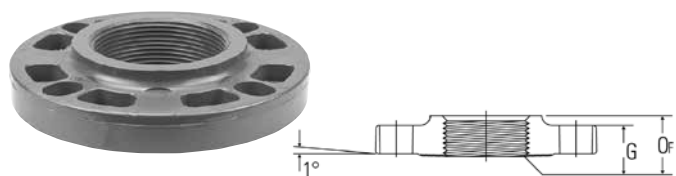

Nominal Size	Universal Part No.	Ctn. Qty.	Approx. Lbs./Ea.	Dim. G	Dim. O _F
2	852-020	10	0.78	0.92	1.18
3	852-030	5	1.26	1.13	1.55
4	852-040	5	2.03	1.24	1.67

Chemtrol
Fig. No.

4519-W Blind Flange, One-Piece (Webbed Design)

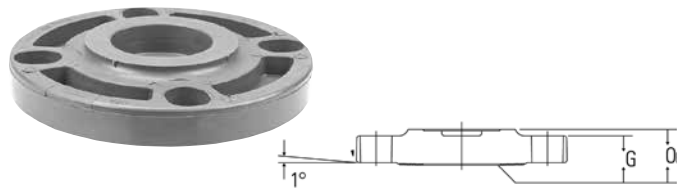

Nominal Size	Universal Part No.	Ctn. Qty.	Approx. Lbs./Ea.	Dim. G	Dim. O _B
2	853-020	12	1.16	0.92	1.13
3	853-030	10	1.41	1.13	1.39
4	853-040	5	2.56	1.24	1.51
6	853-060	5	4.96	1.36	1.60

Note: One-piece webbed flanges have oblong bolt holes which permit mating with ANSI B16.5, 150 lb.; BS 1560, class 150; ISO 2084, PN10; and DIN 2532, PN10 flanges.

4551-A Socket Flange (S), Van Stone

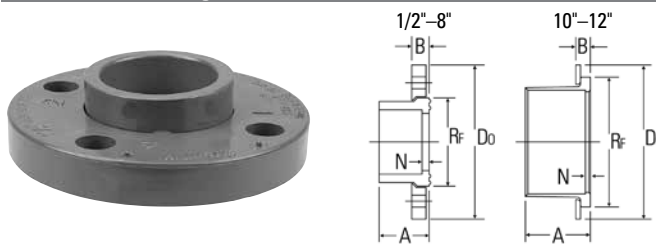

Nominal Size	Universal Part No.	Ctn. Qty.	Approx. Lbs./Ea.	Dim. A	Dim. B	Dim. D _o	Dim. R _f	Dim. N
1/2	854-005	10	0.19	1.00	.50	3.50	1.48	0.11
3/4	854-007	10	0.24	1.13	.50	3.88	1.75	0.11
1	854-010	24	0.38	1.25	.56	4.25	2.04	0.11
1 1/4	854-012	10	0.40	1.38	.63	4.63	2.50	0.11
1 1/2	854-015	12	0.54	1.50	.69	5.00	2.78	0.11
2	854-020	12	0.92	1.63	.75	6.00	3.41	0.11
2 1/2	854-025	5	1.37	1.94	.94	7.00	4.11	0.16
3	854-030	10	1.75	2.40	1.05	7.50	4.81	0.50
4	854-040	10	2.83	2.76	1.16	8.98	6.19	0.48
6	854-060	5	4.19	3.56	1.29	11.00	7.97	0.53
8	854-080	2	6.47	5.01	1.42	13.50	10.45	0.51
10*	854-100	1	10.20	5.83	1.31	16.00	13.29	0.33
12*	854-120	1	17.53	7.45	1.70	19.00	16.00	0.45

*Aluminum ring with PVC coating.

Van Stone Flange Assembly List

Item	Description	Material
1	Connector Hub	PVC
2	Flange Ring	PVC Coated Aluminum
3	Flange Ring	PVC

Chemtrol
Fig. No.

NR 51 Flange Gaskets, for Class 150 Flanges



Note: These gaskets are 1/8" thick, full face polychloroprene (CR), 70 durometer.

Nominal Size	Part No.	Approx. Lbs./Ea.
1/2	Use Figure No. & Nom. Size	0.11
3/4		0.12
1		0.13
1 1/4		0.14
1 1/2		0.15
2		0.20
2 1/2		0.25
3		0.28
4		0.30
6		0.40
8		0.50
10		0.55
12	0.60	

Flanged Fittings* – Fabricated from Molded Components

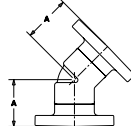
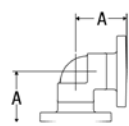
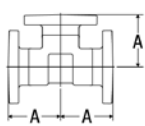

Nominal Size	Fig. No. 4511-12 Flanged Tee		Fig. No. 4507-12 Flanged 90° ELL		Fig. No. 4506-12 Flanged 45° ELL	
	Approx. Lbs./Ea.	Dim. A	Approx. Lbs./Ea.	Dim. A	Approx. Lbs./Ea.	Dim. B
1	1.71	3 3/32	1.19	3 3/32	1.12	2 23/32
1 1/4	2.39	3 19/32	1.60	3 19/32	1.60	3 3/32
1 1/2	3.24	3 31/32	2.06	3 31/32	2.09	3 13/32
2	4.86	4 15/32	3.28	4 15/32	3.16	3 27/32
2 1/2	7.82	5 7/32	5.30	5 7/32	5.08	4 13/32
3	10.67	5 13/32	7.32	5 13/32	6.92	4 25/32
4	16.64	7 3/32	11.60	7 3/32	10.79	5 25/32
6	32.74	9 25/32	22.65	9 25/32	20.84	8 1/2
8	65.79	13 31/32	45.40	13 31/32	42.50	11 5/8

*Flanged fittings are produced by solvent cementing socket flanges to socket fittings with short plain end pipe nipples. They may be ordered as factory fabrications or may be assembled in the field.

Unions

4533 FKM/4533E (EPDM) Socket Union (S x S)

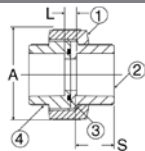

Nominal Size	FKM Part No.	EPDM Part No.	Ctn. Qty.	Approx. Lbs./Ea.	Dim. A	Dim. L	Dim. S*
1/4	857-002	897-002	10	0.07	1.70	0.40	0.64
1/2	857-005	897-005	10	0.16	2.00	0.43	0.89
3/4	857-007	897-007	10	0.27	2.44	0.45	1.01
1	857-010	897-010	10	0.40	2.83	0.43	1.14
1 1/4	857-012	897-012	5	0.87	4.08	0.79	1.26
1 1/2	857-015	897-015	10	0.93	4.08	0.80	1.39
2	857-020	897-020	10	1.83	5.26	0.80	1.51
3	857-030	897-030	5	3.76	7.17	0.90	1.90

The 2 1/2" Socket Union is available as a fabrication from the 3" size Bushed down.

* Socket Depth

Chemtrol
Fig. No.

4533-3-3 FKM / 4533E-3-3 (EPDM) Threaded Union (FPT x FPT)

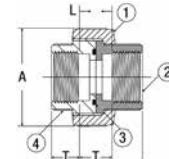

Nominal Size	FKM Part No.	EPDM Part No.	Ctn. Qty.	Approx. Lbs./Ea.	Dim. A	Dim. L	Dim. T*
1/4	858-002	898-002	10	0.11	1.70	1.07	0.31
1/2	858-005	898-005	10	0.16	2.00	1.30	0.43
3/4	858-007	898-007	10	0.28	2.44	1.38	0.45
1	858-010	898-010	10	0.41	2.83	1.51	0.53
1 1/4	858-012	898-012	5	0.90	4.08	2.01	0.55
1 1/2	858-015	898-015	10	0.92	4.08	2.16	0.55
2	858-020	898-020	10	1.82	5.26	2.36	0.57
3	858-030	898-030	5	3.96	7.17	2.88	0.95

The 2 1/2" Thread Union is available as a fabrication from the 3" size Bushed down.

* Thread Joint Engagement

4533-3 FKM / 4533E-3 (EPDM) Female Adapter Union (S x FPT)

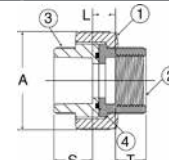

Nominal Size	FKM Part No.	EPDM Part No.	Ctn. Qty.	Approx. Lbs./Ea.	Dim. A	Dim. L	Dim. S*	Dim. T†
1/2	859-005	899-005	10	0.16	2.00	0.84	0.89	0.43
3/4	859-007	899-007	10	0.26	2.44	0.82	1.02	0.45
1	859-010	899-010	10	0.38	2.83	0.90	1.14	0.53
1 1/4	859-012	899-012	10	0.89	4.08	1.29	1.27	0.55
1 1/2	859-015	899-015	10	0.91	4.08	1.32	1.39	0.55
2	859-020	899-020	5	1.81	5.26	1.41	1.51	0.57
3	859-030	899-030	5	3.86	7.17	1.93	1.91	0.95

The 2 1/2" Socket x Thread Union is available as a fabrication from the 3" size Bushed down.

* Socket Depth

† Thread Joint Engagement

Metal Transition Unions

Purchase and Assembly Instructions

Transition Unions result from field assembly. First, the basic plastic Union is chosen, which includes selections for material of construction, O-ring type and connection style, remembering that the Union Nut screws onto the plastic Union Tailpiece. Next, the metal End Connector is chosen for material type and choice of thread connection style. Prior to installation, the mechanic must disassemble the Union, remove and discard the plastic End Connector, and then reassemble with the metal End Connector in its place.

Chemtrol
Fig. No.

TCBR-3 Brass End Connector (FPT)

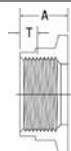

Nominal Size	Universal Part No.	Ctn. Qty.	Approx. Lbs./Ea.	Dim. A	Dim. T*
1/2	↑	1	0.33	1.02	0.43
3/4	↑	1	0.43	1.02	0.45
1	Use Fig. No.	1	0.52	1.19	0.53
1 1/4	& Nom. Size	1	0.85	1.42	0.55
1 1/2	↓	1	1.81	1.42	0.55
2	↓	1	2.74	1.57	0.57
3	↓	1	5.45	2.25	0.95

* Thread Joint Engagement

TCSS-3 Stainless Steel End Connector (FPT)

Nominal Size	Universal Part No.	Ctn. Qty.	Approx. Lbs./Ea.	Dim. A	Dim. T*
1/2	↑	1	0.30	1.02	0.43
3/4	↑	1	0.39	1.02	0.45
1	Use Fig. No.	1	0.47	1.19	0.53
1 1/4	& Nom. Size	1	0.77	1.42	0.55
1 1/2	↓	1	1.64	1.42	0.55
2	↓	1	2.48	1.57	0.57
3	↓	1	4.97	2.25	0.95

* Thread Joint Engagement

TCBR-4 Brass End Connector (MPT)



Nominal Size	Universal Part No.	Ctn. Qty.	Approx. Lbs./Ea.	Dim. A	Dim. T*
1/2	↑	1	0.31	1.66	0.43
3/4	↑	1	0.41	1.69	0.45
1	Use Fig. No.	1	0.49	2.19	0.53
1 1/4	& Nom. Size	1	0.81	2.38	0.55
1 1/2	↓	1	1.72	2.38	0.55
2	↓	1	2.60	2.63	0.57
3	↓	1	5.45	3.50	0.95

* Thread Joint Engagement

Chemtrol
Fig. No.

TCSS-4 Stainless Steel End Connector (MPT)

Nominal Size	Universal Part No.	Ctn. Qty.	Approx. Lbs./Ea.	Dim. A	Dim. T*
1/2	↑	1	0.28	1.66	0.43
3/4	↑	1	0.37	1.69	0.45
1	Use Fig. No.	1	0.44	2.19	0.53
1 1/4	& Nom. Size	1	0.73	2.38	0.55
1 1/2	↓	1	1.56	2.38	0.55
2	↓	1	2.36	2.63	0.57
3	↓	1	4.97	3.50	0.95

* Thread Joint Engagement

Couplings

Chemtrol
Fig. No.

5101 Socket Couplings (S x S)

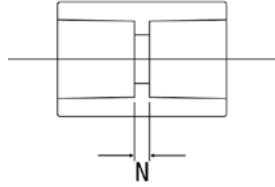

Nominal Size	Universal Part No.	Ctn. Qty.	Approx. Lbs./Ea.	Dim. N
1/4	1829-002	5	0.06	0.12
1/2	1829-005	25	0.10	0.24
3/4	1829-007	15	0.14	0.24
1	1829-010	20	0.22	0.24
1 1/4	1829-012	10	0.31	0.24
1 1/2	1829-015	10	0.40	0.24
2	1829-020	10	0.57	0.24
2 1/2	1829-025	55	0.73	0.19
3	1829-030	5	1.12	0.18
4	1829-040	5	1.94	0.18
6	1829-060	4	4.01	0.23
8*	1829-080	2	9.23	0.22
10	1829-100	1	14.62	0.35
12	1829-120	1	25.26	0.46

5101-R Reducing Socket Coupling (S x S)

Nominal Size	Universal Part No.	Ctn. Qty.	Approx. Lbs./Ea.	Dim. N
3/4 x 1/2	1829-101	5	0.13	0.43
1 x 1/2	1829-130	5	0.20	0.66
1 x 3/4	1829-131	5	0.20	0.54
1 1/4 x 3/4	1829-167	5	0.28	0.71
1 1/4 x 1	1829-168	5	0.30	0.59
1 1/2 x 1/2	1829-209	5	0.37	XXX
1 1/2 x 3/4	1829-210	5	0.35	0.75
1 1/2 x 1	1829-211	5	0.36	0.62
1 1/2 x 1 1/4	1829-212	5	0.38	0.50
2 x 1	1829-249	5	0.50	0.73
2 x 1 1/2	1829-251	5	0.54	0.48
3 x 2	1829-338	5	1.08	1.23
4 x 2	1829-420	5	1.73	1.57
4 x 3	1829-422	5	1.98	1.18

Other Reducing Couplings are produced by solvent cementing Reducer Bushings into Socket Couplings. They may be ordered as factory fabrications or may be assembled in the field.

Chemtrol
Fig. No.

5101-3-3 Thread Coupling (FPT x FPT)

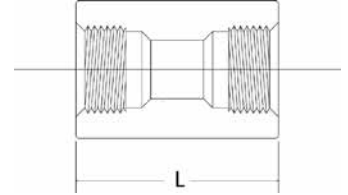

Nominal Size	Universal Part No.	Ctn. Qty.	Approx. Lbs./Ea.	Dim. L
1/4	1830-002	5	0.07	1.40
1/2	1830-005	25	0.08	2.02
3/4	1830-007	25	0.13	2.27
1	1830-010	15	0.21	2.52
1 1/4	1830-012	5	0.31	2.77
1 1/2	1830-015	5	0.46	3.02
2	1830-020	5	0.64	3.27
2 1/2	1830-025	5	0.89	3.75
3	1830-030	5	1.30	3.99
4	1830-040	5	2.31	4.74

5101-3-3-R Reducing Thread Coupling (FPT x FPT)

Nominal Size	Universal Part No.	Ctn. Qty.	Approx. Lbs./Ea.	Dim. L
3/4 x 1/2	1830-101	5	0.15	2.33
1 x 1/2	1830-130	5	0.22	2.69
1 x 3/4	1830-131	5	0.23	2.69
1 1/4 x 3/4	1830-167	5	0.32	2.99
1 1/4 x 1	1830-168	5	0.34	2.99
1 1/2 x 3/4	1830-210	5	0.39	3.15
1 1/2 x 1	1830-211	5	0.40	3.15
1 1/2 x 1 1/4	1830-212	5	0.42	3.15
2 x 1	1830-249	5	0.53	3.39
2 x 1 1/2	1830-251	5	0.58	3.39

Other Reducing Couplings are produced by solvent cementing Reducer Bushings into Socket Couplings. They may be ordered as factory fabrications or may be assembled in the field.

Adapters

Chemtrol
Fig. No.

5103 Female Adapter Coupling (S x FPT)

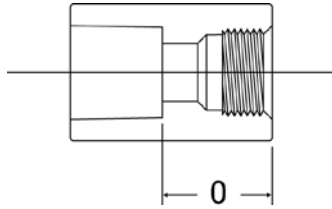

Nominal Size	Universal Part No.	Ctn. Qty.	Approx. Lbs./Ea.	Dim. O
1/4	1835-002	5	0.06	0.76
1/2	1835-005	15	0.10	1.13
3/4	1835-007	10	0.15	1.26
1	1835-010	10	0.23	1.38
1 1/4	1835-012	5	0.34	1.51
1 1/2	1835-015	5	0.43	1.63
2	1835-020	5	0.60	1.76
2 1/2	1835-025	5	0.82	1.97
3	1835-030	5	1.27	2.08
4	1835-040	5	1.13	2.46

5104 Male Adapter (S x MPT)

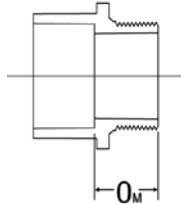

Nominal Size	Universal Part No.	Ctn. Qty.	Approx. Lbs./Ea.	Dim. O_M
1/2	1836-005	25	0.04	0.94
3/4	1836-007	25	0.06	0.96
1	1836-010	25	0.10	1.14
1 1/4	1836-012	10	0.14	1.11
1 1/2	1836-015	10	0.19	1.11
2	1836-020	10	0.27	1.19
2 1/2	1836-025	5	0.56	1.88
3	1836-030	5	0.79	1.97
4	1836-040	5	1.56	2.08

Elbows

Chemtrol
Fig. No.

5107 Socket 90° Elbow (S x S)

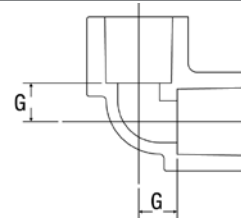

Nominal Size	Universal Part No.	Ctn. Qty.	Approx. Lbs./Ea.	Dim. G
1/4	1806-002	5	0.03	0.33
1/2	1806-005	20	0.12	0.52
3/4	1806-007	20	0.18	0.68
1	1806-010	15	0.27	0.74
1 1/4	1806-012	10	0.41	0.91
1 1/2	1806-015	10	0.54	1.05
2	1806-020	10	0.81	1.26
2 1/2	1806-025	5	1.23	1.52
3	1806-030	5	1.98	1.82
4	1806-040	5	3.44	2.33
6	1806-060	4	8.38	3.48
8*	1806-080	2	16.67	4.53
10	1806-100	1	30.14	5.72
12	1806-120	1	47.77	6.85

* Consult chart on page 39 of this catalog for special rating information.

5107-3 Socket x Thread 90° Elbow (S x FPT)

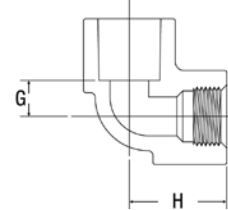

Nominal Size	Universal Part No.	Ctn. Qty.	Approx. Lbs./Ea.	Dim. G	Dim. H
1/2	1807-005	10	0.13	0.52	1.41
3/4	1807-007	10	0.19	0.68	1.70
1	1807-010	10	0.30	0.74	1.88
1 1/4	1807-012	10	0.45	0.91	2.17
1 1/2	1807-015	10	0.59	1.05	2.44
2	1807-020	10	0.86	1.26	2.77

5107-12/5106-12 Flanged Elbow

Flanged fitting center-to-face dimensions may be found on page 21. When ordering, specify the figure number and the nominal size (e.g., 2" Schedule 80 CPVC flanged 90° Elbow-5107-12 2")

Chemtrol
Fig. No.

5107-3-3 Thread 90° Elbow (FPT x FPT)

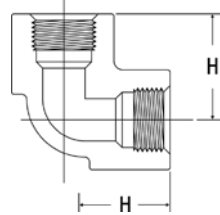

Nominal Size	Universal Part No.	Ctn. Qty.	Approx. Lbs./Ea.	Dim. H
1/4	1808-002	5	0.03	0.97
1/2	1808-005	10	0.13	1.41
3/4	1808-007	25	0.19	1.70
1	1808-010	15	0.30	1.88
1 1/4	1808-012	5	0.45	2.17
1 1/2	1808-015	5	0.59	2.44
2	1808-020	5	0.86	2.77
2 1/2	1808-025	5	1.34	3.30
3	1808-030	5	2.14	3.73
4	1808-040	5	3.85	4.61

5106 Socket 45° Elbow (S x S)

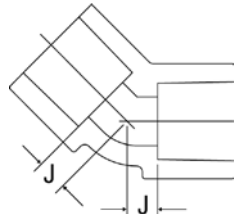

Nominal Size	Universal Part No.	Ctn. Qty.	Approx. Lbs./Ea.	Dim. J
1/4	1817-002	5	0.03	0.18
1/2	1817-005	20	0.10	0.26
3/4	1817-007	10	0.15	0.33
1	1817-010	15	0.24	0.37
1 1/4	1817-012	10	0.34	0.42
1 1/2	1817-015	10	0.47	0.46
2	1817-020	10	0.67	0.60
2 1/2	1817-025	5	0.99	0.67
3	1817-030	6	1.48	0.77
4	1817-040	6	2.62	1.01
6	1817-060	4	6.62	1.74
8*	1817-080	2	13.63	2.20
10	1817-100	1	21.44	2.59
12	1817-120	1	35.59	3.05

*Consult chart on page 39 of this catalog for special rating information.

Chemtrol
Fig. No.

5106-3-3 Thread 45° Elbow (FPT x FPT)

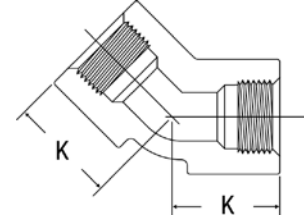

Nominal Size	Universal Part No.	Ctn. Qty.	Approx. Lbs./Ea.	Dim. K
1/4	1819-002	5	0.04	0.82
1/2	1819-005	10	0.11	1.15
3/4	1819-007	10	0.16	1.34
1	1819-010	15	0.27	1.51
1 1/4	1819-012	5	0.38	1.69
1 1/2	1819-015	5	0.52	1.85
2	1819-020	5	0.76	2.12
2 1/2	1819-025	5	1.09	2.45
3	1819-030	6	1.70	2.68
4	1819-040	6	3.06	3.29

Tees

5111 Socket Tee (S x S x S)

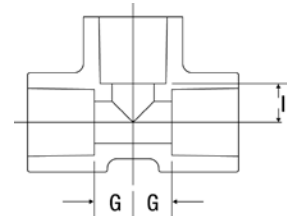

Nominal Size	Universal Part No.	Ctn. Qty.	Approx. Lbs./Ea.	Dim. G	Dim. G	Dim. I
1/4	1801-002	5	0.05	0.33	0.33	0.33
1/2	1801-005	25	0.16	0.52	0.52	0.52
3/4	1801-007	15	0.26	0.68	0.68	0.68
1	1801-010	20	0.39	0.74	0.74	0.74
1 1/4	1801-012	10	0.58	0.91	0.91	0.91
1 1/2	1801-015	10	0.78	1.05	1.05	1.05
2	1801-020	10	1.13	1.26	1.26	1.26
2 1/2	1801-025	5	1.72	1.52	1.52	1.52
3	1801-030	5	2.51	1.82	1.82	1.82
4	1801-040	5	4.41	2.33	2.33	2.33
6	1801-060	4	11.11	3.48	3.48	3.48
8*	1801-080	1	22.28	4.53	4.53	4.53
10	1801-100	1	38.52	5.72	5.72	5.72
12	1801-120	1	63.55	6.85	6.85	6.85

* Consult chart on page 41 of this catalog for special rating information.

Chemtrol
Fig. No.

5111-12 Flanged Tees

Flanged fitting center-to-face dimensions may be found on page 21. When ordering, specify the figure number and the nominal size (e.g., 2" Schedule 80 CPVC flanged tee-5111-12 2")

5111R Reducing Socket Tee (S x S x S)

Nominal Size	Universal Part No.	Ctn. Qty.	Approx. Lbs./Ea.	Dim. G	Dim. G	Dim. I
3/4 x 3/4 x 1/2	1801-101	10	0.19	0.51	0.51	0.62
1 x 1 x 1/2	1801-130	10	0.26	0.52	0.52	0.73
1 x 1 x 3/4	1801-131	10	0.28	0.62	0.62	0.73
1 1/2 x 1 1/2 x 3/4	1801-210	10	0.51	0.66	0.66	1.04
1 1/2 x 1 1/2 x 1	1801-211	10	0.56	0.76	0.76	1.03
2 x 2 x 1/2	1801-247	5	0.65	0.60	0.60	1.29
2 x 2 x 3/4	1801-248	5	0.70	0.70	0.70	1.29
2 x 2 x 1	1801-249	5	0.75	0.80	0.80	1.29
2 x 2 x 1 1/2	1801-251	5	0.89	1.07	1.07	1.29
3 x 3 x 2	1801-338	5	1.92	1.36	1.36	1.84
4 x 4 x 2	1801-420	5	3.02	1.39	1.39	2.34
4 x 4 x 3	1801-422	5	3.62	1.87	1.87	2.34
6 x 6 x 4	1801-532	4	7.69	2.56	2.56	3.52

Other Reducing Tees are produced by solvent cementing Reducer Bushings with Socket Tees. They may be ordered as factory fabrications or may be assembled in the field.

5112 Socket x Thread Tee (S x S x FPT)

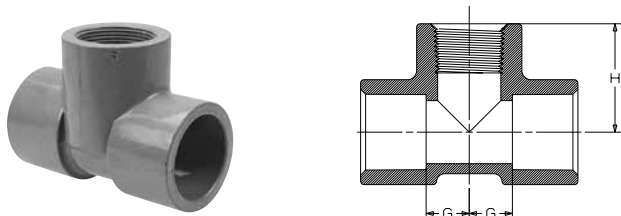

Nominal Size	Universal Part No.	Ctn. Qty.	Approx. Lbs./Ea.	Dim. G	Dim. G	Dim. H
1/2	1802-005	10	0.17	0.52	0.52	1.41
3/4	1802-007	10	0.28	0.68	0.68	1.70
1	1802-010	10	0.43	0.74	0.74	1.88
1 1/4	1802-012	10	0.62	0.91	0.91	2.17
1 1/2	1802-015	10	0.88	1.05	1.05	2.44
2	1802-020	10	1.23	1.26	1.26	2.77

For complete technical information and more, refer to our website at www.chemtrol.com.

Chemtrol
Fig. No.

5112-3-3 Thread Tee (FPT x FPT x FPT)

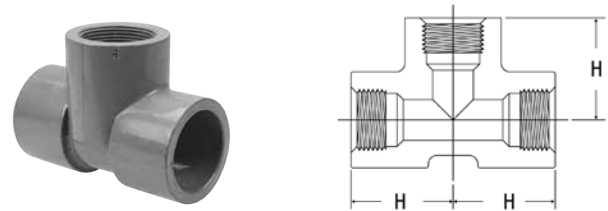

Nominal Size	Universal Part No.	Ctn. Qty.	Approx. Lbs./Ea.	Dim. H
1/4	1805-002	5	0.06	0.97
1/2	1805-005	10	0.17	1.41
3/4	1805-007	15	0.28	1.70
1	1805-010	10	0.43	1.88
1 1/4	1805-012	5	0.62	2.17
1 1/2	1805-015	5	0.88	2.44
2	1805-020	5	1.23	2.77
2 1/2	1805-025	5	1.91	3.30
3	1805-030	5	2.48	3.73
4	1805-040	5	4.88	4.61

Plugs

5116-4 Thread Plug (MPT)

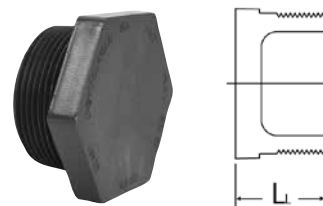

Nominal Size	Universal Part No.	Ctn. Qty.	Approx. Lbs./Ea.	Dim. L
1/4	850-002	25	0.01	0.85
1/2	850-005	50	0.03	1.04
3/4	850-007	50	0.03	1.10
1	850-010	25	0.06	1.25
1 1/4	850-012	10	0.10	1.66
1 1/2	850-015	10	0.14	1.78
2	850-020	10	0.19	1.92
2 1/2	850-025	5	0.29	2.18
3	850-030	5	0.51	2.42
4	850-040	5	0.95	2.81

1/4" Plug is solid, only

Caps

Chemtrol
Fig. No.

5117 Socket Cap* (S)

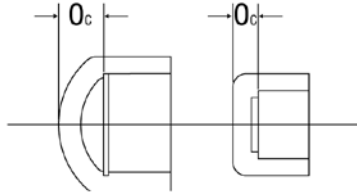

Nominal Size	Universal Part No.	Ctn. Qty.	Approx. Lbs./Ea.	Dim. Oc
1/4	1847-002	5	0.03	0.25
1/2	1847-005	10	0.06	0.39
3/4	1847-007	10	0.09	0.36
1	1847-010	5	0.14	0.41
1 1/4	1847-012	5	0.22	0.39
1 1/2	1847-015	5	0.28	0.41
2	1847-020	5	0.40	0.41
2 1/2	1847-025	5	0.62	1.56
3	1847-030	5	1.00	1.28
4	1847-040	5	1.61	1.57
6	1847-060	5	4.06	2.11

*Sizes 2" and smaller are flat; 2 1/2" and larger are domed.

5117-3 Thread Cap* (FPT)

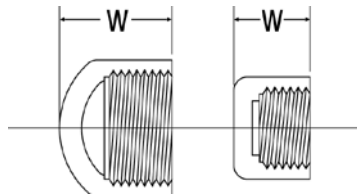

Nominal Size	Universal Part No.	Ctn. Qty.	Approx. Lbs./Ea.	Dim. W
1/4	1848-002	5	0.02	0.89
1/2	1848-005	5	0.07	1.28
3/4	1848-007	5	0.10	1.38
1	1848-010	5	0.16	1.55
1 1/4	1848-012	5	0.25	1.66
1 1/2	1848-015	5	0.31	1.80
2	1848-020	5	0.46	1.92
2 1/2	1848-025	5	0.68	2.34
3	1848-030	5	1.03	3.18
4	1848-040	5	1.85	3.85

*Sizes 2" and smaller are flat; 2 1/2" and larger are domed.

*Chemtrol has seminars available to educate in the design and installation of thermoplastic piping systems. For more information, call our customer service department at **800.343.5455**.*

Bushings

Design Styles

The design style of most bushings is to have a solid wall between the inside and outside connections. Some of the multistep reductions with exceedingly thick cross-sections are not solid. This design style achieves structural support with a web of ribs attaching the inner and outer connection walls, with the open area toward the exterior bushing face. The styles are denoted by W and S for webbed and solid designs respectively.

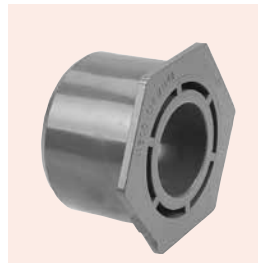

Webbed design

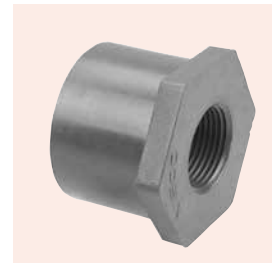

Solid design

Chemtrol
Fig. No.

5118 Flush Socket Reducer Bushing (SPG x S)

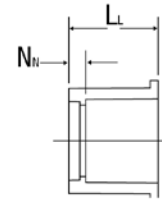

Nominal Size	Universal Part No.	Ctn. Qty.	Approx. Lbs./Ea.	Design Style	Dim. L _L	Dim. N _N
1/2 x 1/4	1837-072	25	0.04	S	1.17	0.53
3/4 x 1/2	1837-101	25	0.06	S	1.15	0.26
1 x 1/2	1837-130	25	0.07	S	1.28	0.39
1 x 3/4	1837-131	25	0.06	S	1.28	0.26
1 1/4 x 1/2	1837-166	10	0.11	S	1.41	0.52
1 1/4 x 3/4	1837-167	10	0.09	S	1.41	0.39
1 1/4 x 1	1837-168	10	0.07	S	1.41	0.27
1 1/2 x 1/2	1837-209	10	0.13	W	1.53	0.64
1 1/2 x 3/4	1837-210	10	0.11	S	1.53	0.51
1 1/2 x 1	1837-211	10	0.09	S	1.53	0.39
1 1/2 x 1 1/4	1837-212	10	0.07	S	1.53	0.26
2 x 1/2	1837-247	10	0.27	W	1.66	0.77
2 x 3/4	1837-248	10	0.27	W	1.66	0.64
2 x 1	1837-249	10	0.27	W	1.66	0.52
2 x 1 1/4	1837-250	5	0.23	S	1.66	0.39
2 x 1 1/2	1837-251	10	0.21	S	1.66	0.27
2 1/2 x 1	1837-289	5	0.46	W	1.94	0.80
2 1/2 x 1 1/2	1837-291	5	0.39	S	1.94	0.55
2 1/2 x 2	1837-292	5	0.26	S	1.93	0.42
3 x 1 1/2	1837-337	5	0.75	W	2.41	1.02
3 x 2	1837-338	5	0.70	S	2.41	0.90
3 x 2 1/2	1837-339	5	0.49	S	2.41	0.63

Chemtrol
Fig. No.

5118 Flush Socket Reducer Bushing (SPG x S) (cont.)

Nominal Size	Universal Part No.	Ctn. Qty.	Approx. Lbs./Ea.	Design Style	Dim. L _L	Dim. N _N
4 x 2	1837-420	5	1.25	W	2.80	1.29
4 x 3	1837-422	5	1.01	S	2.80	0.90
6 x 4	1837-532	5	2.97	S	3.05	0.77
8 x 6	1837-585	2	6.00	S	4.58	1.55
10 x 6	1837-422	1	10.80	W	5.57	2.54
10 x 8	1837-626	1	9.36	S	5.57	1.07
12 x 8	1837-668	1	18.79	W	6.57	2.07
12 x 10	1837-670	1	12.78	S	6.57	1.07

Other size reductions are produced by solvent cementing appropriate Reducer Bushings together. They may be ordered as factory fabrications or may be assembled in the field.

5118-3 Flush Spigot x Thread Reducer Bushing (SPG x FPT)

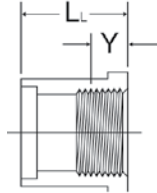

Nominal Size	Universal Part No.	Ctn. Qty.	Approx. Lbs./Ea.	Design Style	Dim. L _L	Dim. Y*
1/2 x 1/4	1838-072	25	0.03	S	1.17	0.31
3/4 x 1/2	1838-101	25	0.03	S	1.29	0.43
1 x 1/2	1838-130	25	0.07	S	1.56	0.43
1 x 3/4	1838-131	25	0.06	S	1.56	0.45
1 1/4 x 1/2	1838-166	10	0.15	S	1.66	0.43
1 1/4 x 3/4	1838-167	10	0.13	S	1.66	0.45
1 1/4 x 1	1838-168	10	0.11	S	1.66	0.53
1 1/2 x 1/2	1838-209	10	0.23	S	1.77	0.43
1 1/2 x 3/4	1838-210	10	0.21	S	1.77	0.45
1 1/2 x 1	1838-211	10	0.19	S	1.77	0.53
1 1/2 x 1 1/4	1838-212	10	0.13	S	1.77	0.55
2 x 1/2	1838-247	10	0.36	S	1.91	0.43
2 x 3/4	1838-248	10	0.34	S	1.91	0.45
2 x 1	1838-249	10	0.32	S	1.91	0.53
2 x 1 1/4	1838-250	10	0.26	S	1.91	0.55
2 x 1 1/2	1838-251	10	0.21	S	1.91	0.55
2 1/2 x 2	1838-292	5	0.32	S	2.17	0.57
3 x 2	1838-338	5	0.73	S	2.41	0.57
3 x 2 1/2	1838-339	5	0.57	S	2.41	0.87
4 x 2	1838-420	5	1.30	W	2.80	0.57
4 x 3	1838-422	5	1.06	S	2.80	0.95

Other size reductions are produced by solvent cementing appropriate Reducer Bushings together. They may be ordered as factory fabrications or may be assembled in the field.

*Typical male component engagement, hand tight (L₁ in ANSI B1.20.1 thread spec.) plus 1 1/2 turns.

Chemtrol
Fig. No.

5118-3-4 Flush Thread Reducer Bushing (MPT x FPT)

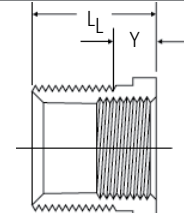

Nominal Size	Universal Part No.	Ctn. Qty.	Approx. Lbs./Ea.	Design Style	Dim. L _L	Dim. Y*
1/2 x 1/4	1839-072	25	0.02	S	0.95	0.25
3/4 x 1/2	1839-101	25	0.03	S	0.95	0.25
1 x 1/2	1839-130	25	0.06	S	1.24	0.38
1 x 3/4	1839-131	25	0.05	S	1.24	0.38
1 1/4 x 1/2	1839-166	10	0.13	S	1.27	0.38
1 1/4 x 3/4	1839-167	10	0.11	S	1.27	0.38
1 1/4 x 1	1839-168	10	0.09	S	1.27	0.38
1 1/2 x 1/2	1839-209	10	0.20	S	1.28	0.38
1 1/2 x 3/4	1839-210	10	0.18	S	1.28	0.38
1 1/2 x 1	1839-211	10	0.17	S	1.28	0.38
1 1/2 x 1 1/4	1839-212	10	0.11	S	1.28	0.38
2 x 1/2	1839-247	5	0.30	S	1.32	0.38
2 x 3/4	1839-248	5	0.28	S	1.32	0.38
2 x 1	1839-249	5	0.28	S	1.32	0.38
2 x 1 1/4	1839-250	5	0.27	S	1.32	0.38
2 x 1 1/2	1839-251	5	0.15	S	1.32	0.38
2 1/2 x 2	1839-292	5	0.24	S	2.18	0.57
3 x 1 1/2	1839-337	5	0.64	W	2.42	0.55
3 x 2	1839-338	5	0.59	S	2.42	0.57
3 x 2 1/2	1839-339	5	0.54	S	2.42	0.87
4 x 2	1839-420	5	1.01	W	2.81	0.57
4 x 3	1839-422	5	0.95	S	2.81	0.95

Other size reductions are produced by solvent cementing appropriate Reducer Bushings together. They may be ordered as factory fabrications or may be assembled in the field.

*Typical male component engagement, hand tight (L₁ in ANSI B1.20.1 thread spec.) plus 1 1/2 turns.

Class 150 Flanges

For flange dimensions that comply with ANSI B16.5, 150 lb., steel flanges, see Reference Data on following pages.

5151-H Socket Flange (S), One-Piece (Solid)

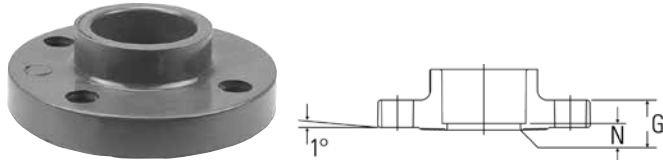

Nominal Size	Universal Part No.	Ctn. Qty.	Approx. Lbs./Ea.	Dim. G	Dim. N
1/2	1851-H05	10	0.22	0.54	0.20
3/4	1851-H07	15	0.31	0.61	0.17
1	1851-H10	10	0.45	0.68	0.18
1 1/4	1851-H12	5	0.59	0.72	0.20
1 1/2	1851-H15	10	0.73	0.82	0.21
2	1851-H20	10	1.12	0.91	0.26
2 1/2	1851-H25	5	1.77	1.02	0.20
3	1851-H30	10	2.27	1.13	0.28
4	1851-H40	10	3.17	1.24	0.31
6	1851-H60	5	5.04	1.36	0.31
8	1851-H80	2	9.35	1.52	0.35

5151-H-3 Thread Flange (FPT), One-Piece (Solid)

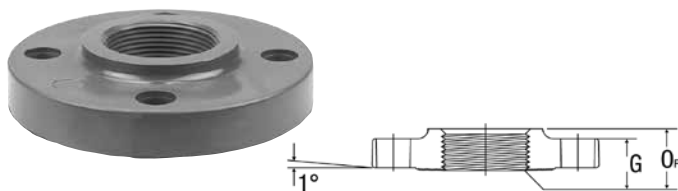

Nominal Size	Universal Part No.	Ctn. Qty.	Approx. Lbs./Ea.	Dim. G	Dim. OF
1/2	1852-H05	10	0.23	0.54	0.88
3/4	1852-H07	10	0.34	0.61	0.91
1	1852-H10	10	0.44	0.68	1.08
1 1/4	1852-H12	5	0.55	0.72	1.11
1 1/2	1852-H15	5	0.69	0.82	1.12
2	1852-H20	5	1.05	0.91	1.17
2 1/2	1852-H25	5	1.65	1.02	1.42
3	1852-H30	5	1.84	1.13	1.55
4	1852-H40	5	2.80	1.24	1.67

*Chemtrol has seminars available to educate in the design and installation of thermoplastic piping systems. For more information, call our customer service department at **800.343.5455**.*

Chemtrol
Fig. No.

5119-H Blind Flange, One-Piece (Solid)

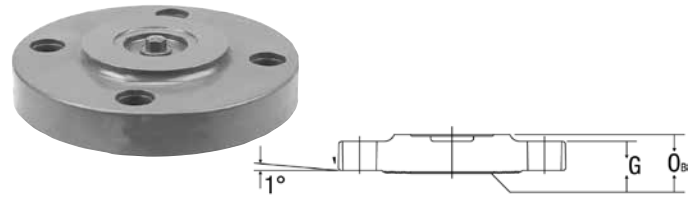

Nominal Size	Universal Part No.	Ctn. Qty.	Approx. Lbs./Ea.	Dim. G	Dim. OB
1/2	1853-H05	5	0.28	0.54	0.76
3/4	1853-H07	5	0.34	0.61	0.83
1	1853-H10	5	0.48	0.68	0.88
1 1/4	1853-H12	5	0.63	0.72	0.95
1 1/2	1853-H15	5	0.81	0.82	1.04
2	1853-H20	5	1.24	0.91	1.12
2 1/2	1853-H25	5	2.03	1.02	1.22
3	1853-H30	5	2.65	1.13	1.39
4	1853-H40	5	3.94	1.24	1.57
6	1853-H60	5	6.93	1.36	1.60
8	1853-H80	2	11.23	1.51	1.77

5151-W Socket Flange (S), One-Piece (Webbed Design)

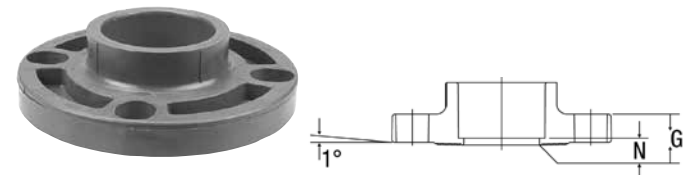

Nominal Size	Universal Part No.	Ctn. Qty.	Approx. Lbs./Ea.	Dim. G	Dim. N
2	1851-020	10	0.89	0.91	0.26
3	1851-030	10	1.80	1.13	0.28
4	1851-040	10	2.72	1.24	0.31
6	1851-060	5	4.14	1.36	0.31

Note: One-piece webbed flanges have oblong bolt holes which permit mating with ANSI B16.5, 150 lb.; BS 1560, class 150; ISO 2084, PN10; and DIN 2532, PN10.

5151-W-3 Thread Flange (FPT), One-Piece (Webbed Design)

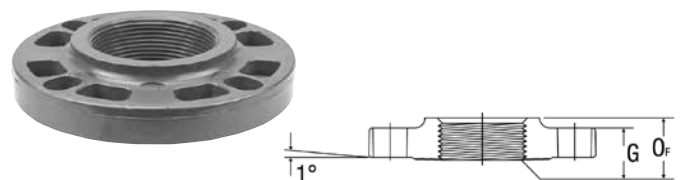

Nominal Size	Universal Part No.	Ctn. Qty.	Approx. Lbs./Ea.	Dim. G	Dim. OF
2	1852-020	5	0.88	0.91	1.17
3	1852-030	5	1.73	1.13	1.55
4	1852-040	5	2.53	1.24	1.67

Chemtrol
Fig. No.

5119-W Blind Flange, One-Piece (Webbed Design)

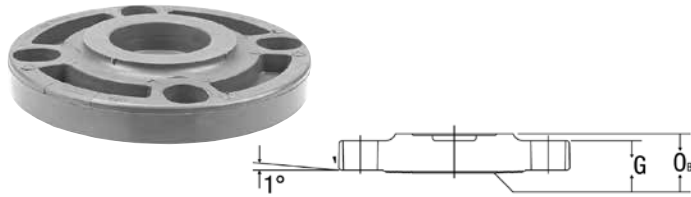

Nominal Size	Universal Part No.	Ctn. Qty.	Approx. Lbs./Ea.	Dim. G	Dim. O _B
2	1853-020	5	0.88	0.91	1.17
3	1853-030	5	1.98	1.13	1.39
4	1853-040	5	2.88	1.24	1.51
6	1853-060	5	5.07	1.36	1.60

Note: One-piece webbed flanges have oblong bolt holes which permit mating with ANSI B16.5, 150 lb.; BS 1560, class 150; ISO 2084, PN10; and DIN 2532, PN10.

5151-A Socket Flange (S), Van Stone

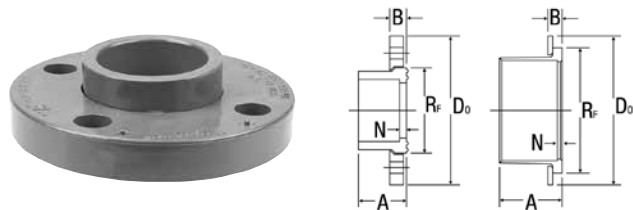

Nominal Size	Universal Part No.	Ctn. Qty.	Approx. Lbs./Ea.	Dim. A	Dim. B	Dim. D _o	Dim. R _f	Dim. N
1/2	1854-005	10	0.21	1.00	.50	3.49	1.48	0.11
3/4	1854-007	15	0.26	1.12	.50	3.86	1.75	0.11
1	1854-010	10	0.41	1.25	.56	4.24	2.04	0.11
1 1/4	1854-012	5	0.44	1.37	.63	4.61	2.50	0.11
1 1/2	1854-015	10	0.59	1.50	.69	4.99	2.78	0.11
2	1854-020	10	1.00	1.62	.75	5.98	3.41	0.11
2 1/2	1854-025	5	1.49	1.93	.94	6.98	4.11	0.15
3	1854-030	10	1.87	2.40	1.04	7.48	4.80	0.50
4	1854-040	10	2.84	2.75	1.16	8.95	6.17	0.48
6	1854-060	5	4.88	3.55	1.28	10.97	7.95	0.53
8	1854-080	2	13.13	5.00	1.42	13.46	10.42	0.50

Van Stone Flange Assembly List

Item	Description	Material
1	Connector Hub	CPVC
3	Flange Ring	CPVC

Chemtrol
Fig. No.

NR 51 Flange Gaskets, for Class 150 Flanges

Note: These gaskets are 1/8" thick, full face polychloroprene (CR), 70 durometer.



Nominal Size	Part No.	Approx. Lbs./Ea.
1/2	↑ Use Figure No. & Nom. Size ↓	0.11
3/4		0.12
1		0.13
1 1/4		0.14
1 1/2		0.15
2		0.20
2 1/2		0.25
3		0.28
4		0.30
6		0.40
8	0.50	

Flanged Fittings*— Fabricated from Molded Components

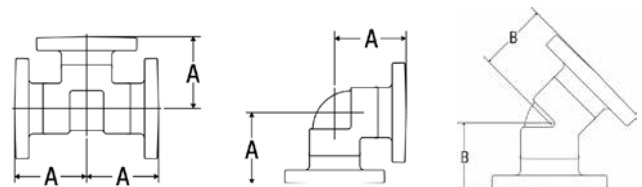

Nominal Size	Fig. No. 5111-12 Flanged Tee		Fig. No. 5107-12 Flanged 90° ELL		Fig. No. 5106-12 Flanged 45° ELL	
	Approx. Lbs./Ea.	Dim. A	Approx. Lbs./Ea.	Dim. A	Approx. Lbs./Ea.	Dim. B
1	1.98	3 3/32	1.34	3 3/32	1.31	2 23/32
1 1/4	2.75	3 19/32	1.86	3 19/32	1.79	3 3/32
1 1/2	3.49	3 31/32	2.35	3 31/32	2.27	3 13/32
2	5.23	4 15/32	3.54	4 15/32	3.40	3 27/32
2 1/2	8.38	5 7/32	5.67	5 7/32	5.43	4 13/32
3	11.32	5 13/32	7.85	5 13/32	7.35	4 25/32
4	17.36	7 3/32	12.07	7 3/32	11.29	5 25/32
6	32.74	9 25/32	24.50	9 25/32	22.75	8 1/2
8	—	—	—	—	—	—

* Flanged fittings are produced by solvent cementing socket flanges to socket fittings with short plain end pipe nipples. They may be ordered as factory fabrications or may be assembled in the field.

*Chemtrol sells its products through a select group of highly trained distributors. Please call **800.343.5455** for a listing of distributors in your area.*

Unions

Chemtrol
Fig. No.

5133 FKM/5133E (EPDM) Socket Union (S x S)

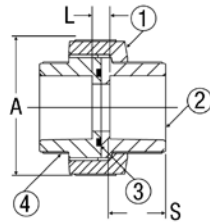

Nominal Size	FKM Part No.	EPDM Part No.	Ctn. Qty.	Approx. Lbs./Ea.	Dim. A	Dim. L	Dim. S*
1/4	1857-002	1897-002	5	0.10	1.70	0.41	0.64
1/2	1857-005	1897-005	10	0.17	1.99	0.43	0.89
3/4	1857-007	1897-007	10	0.30	2.43	0.44	1.02
1	1857-010	1897-010	5	0.43	2.82	0.43	1.14
1 1/4	1857-012	1897-012	5	0.94	4.07	0.79	1.27
1 1/2	1857-015	1897-015	5	1.01	4.07	0.81	1.39
2	1857-020	1897-020	5	1.98	5.24	0.80	1.52
3	1857-030	1897-030	5	3.77	7.15	0.94	1.91

The 2 1/2" Socket Union is available as a fabrication from the 3" size Bushed down.

* Socket Depth

Chemtrol
Fig. No.

5133-3 FKM / 5133E-3 (EPDM) Female Adapter Union (S x FPT)

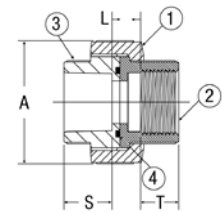

Nominal Size	FKM Part No.	EPDM Part No.	Ctn. Qty.	Approx. Lbs./Ea.	Dim. A	Dim. L	Dim. S*	Dim. T†
1/2	1859-005	1899-005	10/5	0.163	1.99	0.84	0.89	0.43
3/4	1859-007	1899-007	10	0.282	2.43	0.81	1.02	0.45
1	1859-010	1899-010	10	0.411	2.82	0.90	1.14	0.53
1 1/4	1859-012	1899-012	10	0.943	4.07	1.29	1.27	0.55
1 1/2	1859-015	1899-015	10	0.967	4.07	1.32	1.39	0.55
2	1859-020	1899-020	5	1.880	5.24	1.41	1.52	0.57
3	1859-030	1899-030	5	4.100	7.15	1.90	1.91	0.95

* Socket Depth
† Thread Joint Engagement

5133-3-3 FKM/5133E-3-3 (EPDM) Threaded Union (FPT x FPT)

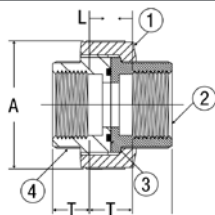

Nominal Size	FKM Part No.	EPDM Part No.	Ctn. Qty.	Approx. Lbs./Ea.	Dim. A	Dim. L	Dim. S*
1/4	1858-002	1898-002	5	0.10	1.69	1.07	0.31
1/2	1858-005	1898-005	5	0.17	1.99	1.30	0.43
3/4	1858-007	1898-007	5	0.30	2.43	1.37	0.45
1	1858-010	1898-010	5	0.44	2.82	1.51	0.53
1 1/4	1858-012	1898-012	5	0.97	4.07	2.01	0.55
1 1/2	1858-015	1898-015	5	1.00	4.07	2.16	0.57
2	1858-020	1898-020	5	1.98	5.24	2.36	0.57
3	1858-030	1898-030	5	3.99	7.15	2.685	0.95

* Thread Joint Engagement

Valve Installation

For socket-end valves refer to the solvent cement joining instructions for PVC and CPVC, and the heat fusion joining instructions for PP and PVDF in the *Chemtrol Thermoplastic Piping Technical Manual*. For threaded-end valves usually one or two turns beyond hand-tight using a suitable strap wrench, if necessary, is sufficient. Do not overtighten threads. ANSI B1.20.1 defines hand tight as 4 to 5 threads for sizes through 2" and 5 to 6-3/4 threads for sizes greater than 2". For flanged-end valves refer to the plastic flange joining instructions in the *Chemtrol Thermoplastic Piping Technical Manual*. CAUTION: Over tightening threads may result in damage to products.

Ball and Check Valves

When joining union-end valves, or when flanging end connectors, never make the joint to the end connectors while they are attached to the valve body. Remove the union nuts and end connectors from the valve cartridge first. Slide the union nut (smallest bore first) over the pipe or nipple and flange hub (when flanging) before making the joint to the end connector.

After allowing the proper joint drying time, or cooling time in the case of PP and PVDF, end connections may be joined to the valve cartridge. O-rings provide the seal between the valve cartridge faces and the end connectors. Ensure that these O-rings are clean and in their proper grooves before slipping the valve cartridge between its end connectors. Slide the union nuts over the end connectors and screw onto the valve cartridge threads, no more than hand tight. Once the end connector engages the O-ring seal, no more than 1/8 to 1/4 turn of the union nut will fully compress the O-ring in its groove. CAUTION: Over tightening threads may result in damage to products.

The pipe supports surrounding the valve must be loose and the adjoining piping must be well aligned with the valve. The union nuts cannot be expected to bend and/or stretch the adjoining pipe in order to allow the end connectors to make the required flush seal against the valve cartridge faces.

3-Way Valve Seat Adjustment - The seat-carrier in multiport and diverter valves is of the Model-A design, meaning that it is not fastened to the valve body with internal threads. Therefore, the union nut on the valve end with "ADJ" marked on the body serves the dual purpose of external adjustment for "squeeze" on the operating envelope within the cartridge, preventing leakage across the ball, as well as compression of the face-seal, preventing shell leakage at the cartridge face. Upon installation of multiport or diverter valves, with the handle parallel with the body and fully against the handle/body stop, tighten that union nut on the "ADJ" body end while minutely operating the handle off the stop and back to the stop. The handle turning torque should become snug, but not excessive when the valve is properly adjusted for leak-free operation. If proper adjustment cannot be made by hand tightening the union nut (valves larger than 1-1/2"), a suitable strap-wrench may be used.

CAUTION: Over tightening threads may result in damage to products.

Check Valves - Check valves should be installed at least four feet from the discharge side of a pump. Ball chatter and internal damage may result if fluid flow is too turbulent. Also, in keeping with good mechanical design practice, the upper threshold of fluid flow recommended from Chemtrol products is five feet per second.

The valves may be installed vertically or horizontally (refer to the preceding page for minimum seating head requirements), but the molded-in flow arrow on the valve cartridge must be installed in the direction of the fluid flow such that reverse flow will be checked.

Foot Valve Conversion - Foot valve screen housing assemblies are available to convert ball check valves to foot valves in the field. The assemblies are to be installed on the supply side of a standard Chemtrol Ball Check Valve, replacing the union nut and end connector. Foot valves are normally installed in an open tank or sump on the suction side of a pump. Its function is to screen debris from entering the pump.

Vent Valve Conversion - The ball in a standard Chemtrol Ball Check Valve is intended by design to have a greater density than the fluid medium. When installed in the upright (seat down – arrow on body pointed in direction of normal flow) to horizontal positions, gravitational force on the ball allows it to sink in the fluid and seal at the seat in order to prevent back-flow when directional flow is ceased (e.g., pump stops). However, the mechanical designer sometimes wants air or gas to be vented from a piping system or vessel as fluid fills the system, but to check flow of fluid beyond the vent tube. As fluid is evacuated from the system or vessel, the vent valve must open to prevent formation of a vacuum. The field conversion of the check valve to the venting function requires the replacement of the standard ball with a polypropylene ball, which will float in water or fluids of greater density. A vent valve must be installed in the inverted vertical position (seat up – arrow on body pointed in opposite direction of normal venting). The floater ball must also be chemically resistant to the medium. Failure to follow these instructions may cause stress cracking to the polypropylene ball (e.g., bleach, concentrated sulfuric or nitric acids).

Butterfly Valves

Chemtrol® Butterfly Valves are installed by bolting between two pipe flanges and may be mounted in any position. They are designed to be operated with pipes up to and including Schedule 80 wall thicknesses. If the I.D. of connecting pipe or equipment is smaller than Schedule 80, it will be necessary to chamfer the inside edge to avoid interference with the rotating butterfly disk.

Alignment - Excessive angular misalignment and/or axial displacement is detrimental to proper function of the companion flange face-seals built into the valves. For reference, ANSI/ASME B31.3, Code for Pressure Piping, Chemical Plant, and Petroleum Refinery Piping, stipulates that flange faces shall be aligned to the design plane (butterfly valve in this case) to within 1/16" in./ft. (0.5%) maximum measured across any diameter, and flange bolt holes shall be aligned to within 1/8" maximum offset.

Insertion in System - The end flaps of the elastomeric seat (Model B) or the O-rings (Model C) serve as face-seals for the companion flanges to be mounted on each side of the butterfly valve. Other gaskets are not to be used. Flange clearance required for insertion is given in the bolting chart below. For installation between the flanges, the valve should be partially open, but not so far as to damage the edge of the disk on mating flanges. If the spacing between mating flanges is tight, the valve sealing surface should be coated with a lubricant to prevent distortion during installation. If more than soapy water is required, a non-hydrocarbon base material, such as silicone grease, may be used on EPDM face-seals. An oil-based lubricant, such as glycerin, is acceptable for FKM face-seals. Insert valve in desired position and install bolts with metal back-up washers (corresponding to ANSI B18.22.1, designated N – narrow washers previously known as SAE series washers) under both the bolt head and nut. Note: Bolt size x washer OD – 1/2", 1.092"; 5/8", 1.342"; 3/4", 1.499"; 7/8", 1.780".

Bolting - Snug up the bolts finger-tight so that the circumference of the inside bore of each companion flange evenly touches the face-seals of the butterfly valve. Make sure the valve is properly aligned before proceeding. Then, use of a torque wrench for pulling on the nuts is suggested for actual bolt tightening. It is critical that bolts be equally tightened in a sequential pattern diametrically opposed to each other, and that the final recommended bolt torque be accomplished through a minimum of three progressive stages of tightening. The recommended progressive tightening pattern and the final torque levels are shown on the following chart and diagram:

Valve Size (Nom.)	Flange Clearance Model B (in.)	Flange Clearance Model C (in.)	Bolt Diameter (in.)	Bolts Required (No.)	Recommended Bolt Torque ² (Ft.-Lbs.)
* 2	-	1.69	5/8	4	20-30
* 2 1/2	-	1.81	5/8	4	20-30
3	2.00	1.81	5/8	4 or 8 ¹	20-30
4	2.25	2.06	5/8	8	20-30
6	2.81	2.19	3/4	8	33-50
* 8	-	2.38	3/4	8	33-50
* 10	-	2.69	7/8	12	53-75

* Available in Model C only.

1 Four (4) bolt hole pattern for ANSI 150 flange pattern; eight (8) bolt hole pattern for DIN standard flange pattern.

2 Refers to well-lubricated bolts.

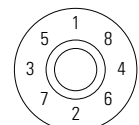

When valve installation is complete, open and close the valve to check for ease of operation and proper alignment. Caution: Do not allow the valve to support the weight of any related piping. Direct support is required when mechanical operators or actuators are utilized. Failure to follow these instructions may result in damage to products or property.

Valve Maintenance

Valve repair should only be performed by qualified maintenance personnel. Contact the nearest Chemtrol distributor should further information be required.

Ball Valves

Should a valve need repair, depressurize and drain the system on all sides of the valve. Loosen the valve union nuts and slide them back over the end connectors. To minimize downtime, it may be advisable to have a replacement valve cartridge ready to install in place of the one to be repaired. An advantage of the Chemtrol design is that the current model is interchangeable with all earlier models. Disassemble valve cartridge following the instructions provided with the valve.

Butterfly Valves

Following testing and soon after commissioning of a system, if either the Model B or Model C valve develops a leak at the top bearing, the flange face-seal(s), and/or across the valve disk, the most likely cause of the leak would be inappropriate selection of the elastomeric seat and seals. In this case, check the NIBCO Chem-Guide for compatibility with the fluid medium. If there is leakage at the flange face-seal(s) only, further tightening of bolts will almost never stop any flange joint leak. Rather, the remedy is to disassemble the joint and reseal the flanges on the valve face-seals, being careful to follow the bolting paragraph under the butterfly valve installation instructions.

After extended operation, if leakage should occur at the top bearing or across the valve disk of either the Model B or Model C valve, this is a likely cause of wear to the elastomeric seat and/or O-ring seals, requiring their replacement. In most cases, valve replacement may be less expensive than parts replacement. In fact, the Model C valve cannot be disassembled. Only the handle assembly and O-ring face-seals may be replaced. Otherwise, replacement of the entire Model C valve is recommended. When maintenance to a Model B valve is required, refer to the disassembly and reassembly instructions included with the valve.

General Design and Installation Guidelines

- The manufacturer does NOT recommend running a thermoplastic piping system with velocity greater than 5 feet/sec.
- **WARNING:** Do NOT close a quarter turn valve quickly. This will create shock in the system and cause damage to property or personal injury.
- Installing thermoplastic piping components at temperatures at 40°F requires extra precaution in handling because the material may be at increased risk of impact damage.
- **WARNING:** Follow the recommended bolt tightening techniques, including sequence of tightening and final torque values, for flanges and butterfly valves because failure to do so will result in damage to the product.
- Do not allow primer or solvent cement to come in contact with the sealing face of valve end connectors or internal components of the valve.
- Valves must be installed with the molded-in flow arrow(s) on the valve cartridge facing in the direction of the fluid flow.
- To ensure comprehensive chemical compatibility, a piping system must take into consideration the chemical resistance of all system components, including, but not limited to, plastic components, solvent cements or thread pastes (if applicable), elastomeric seals, all valve components and lubricants. Testing under field conditions may be the best way to ensure selected materials will work in a particular application.
- Consult the Chemtrol Thermoplastic Piping Technical Manual for additional design and installation requirements for Chemtrol products.

Actuator Mounting Data

The same plastic modular mounting kits, including fastener hardware and drive couplings, used for factory assembly, are available for field assembly of Chemtrol® actuation equipment to installed valves. When designing the CPVC mounting brackets and adapter plates we recognized that some facilities specify Chemtrol® plastic valves, but are standardized on other actuator brands. Therefore, holes in the mounting platforms are slotted and the heights of platforms over valve stems are set to offer the broadest mounting flexibility. For many reasons, including economic, the use of Chemtrol® mount kits is also encouraged when joining Chemtrol® valves to other actuator brands, and the critical data on this page is offered to facilitate adaptation.

TU Tru-Bloc Ball Valve Min. Torque & Actuator-Mounting Dimensions

Valve Size	Min. Torque (in. lbs.)	A	B	C	D
1/2	40	3.62	2.87	1.35	0.96
3/4	50	3.62	2.87	1.87	1.53
1	50	3.62	2.87	2.16	1.70
1 1/4 / 1 1/2	90	5.25	4.50	3.01	2.46
2	170	5.25	4.50	3.75	3.07
3	360	7.00	6.00	4.75	4.00
4/6	540	8.35	7.35	5.81	5.31

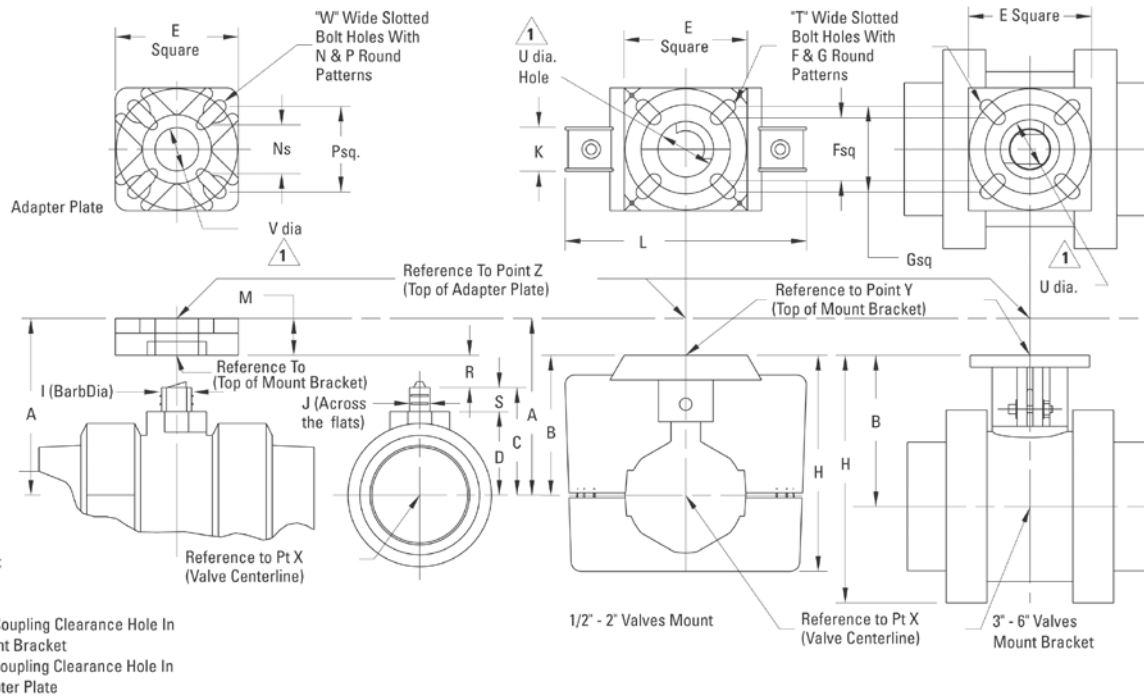

Valve Size	E		F		G		H	I	J	K	L	M	N		P		R	S	T	U	V	W
	B. C.	Sq.	B. C.	Sq.	B. C.	Sq.							B. C.	Sq.								
1/2	2.50	1.82	1.29	2.46	1.74	4.43	0.422	0.280	0.90	4.89	0.75	1.40	0.99	2.60	1.84	1.34	0.57	0.28	1.13	0.88	0.26	
3/4	2.50	1.82	1.29	2.46	1.74	4.43	0.613	0.450	0.90	4.89	0.75	1.40	0.99	2.60	1.84	1.00	0.34	0.28	1.13	0.88	0.26	
1	2.50	1.82	1.29	2.46	1.74	4.43	0.613	0.450	0.90	4.89	0.75	1.40	0.99	2.60	1.84	0.71	0.46	0.28	1.13	0.88	0.26	
1 1/4 / 1 1/2	3.00	2.46	1.74	3.02	2.14	7.22	0.738	0.535	1.26	7.32	0.75	1.40	0.99	3.02	2.14	1.49	0.55	0.34	1.64	0.88	0.32	
2	3.00	2.46	1.74	3.02	2.14	7.22	0.988	0.755	1.26	7.32	0.75	1.40	0.99	3.02	2.14	0.75	0.68	0.34	1.64	0.88	0.32	
3	5.00	2.74	1.94	5.16	3.65	9.59	1.240	0.900	-	-	1.00	1.84	1.30	5.16	3.65	1.25	0.75	0.32	1.83	1.02	0.40	
4/6	5.00	4.20	2.97	5.16	3.65	11.74	2.090	1.260	-	-	1.00	1.84	1.30	5.16	3.65	1.54	0.50	0.39	3.03	1.02	0.40	

Actuator Mounting Data

Ball Valve Mount Kit Part Numbers & Coupling Dimensions

Valve Size	Mount Kit Pt. #	Actuator Type ¹	Drive Coupling Dimensions								
			A	B	C	D	E	F	G	H	J
1/2	T111556	A/A, A/SR & E	0.351	0.437	3.08	1.81	0.67	0.281	1.10	0.46	0.42
3/4	T111557	A/A, A/SR & E	0.351	0.437	2.51	1.24	0.44	0.451	1.10	0.46	0.42
1	T111558	A/A, A/SR & E	0.351	0.437	2.34	1.07	0.56	0.451	1.10	0.46	0.42
1 1/4 / 1 1/2	T111559	A/A & E	0.351	0.437	3.24	1.97	0.65	0.539	1.61	0.46	0.45
	T111566	A/SR	0.430	0.549	3.28	1.97	0.65	0.539	1.61	0.57	0.49
2	T111560	A/A	0.430	0.549	2.64	1.33	0.78	0.761	1.61	0.50	0.46
	T111567	A/SR	0.548	0.704	2.64	1.33	0.78	0.761	1.61	0.50	0.46
	T111770	E	0.351	0.437	2.60	1.33	0.78	0.761	1.61	0.46	0.42
3	T111561	A/A & E	0.548	0.704	3.46	1.90	0.86	0.911	1.50	0.50	0.46
	T111568	A/SR	0.666	0.882	2.46	1.90	0.86	0.911	1.50	0.50	0.46 ²
4/6	T111562	A/A	0.666	0.882	3.44	1.88	0.59	1.266	1.75	0.50	0.40
	T111569	A/SR	0.863	1.000	3.44	1.88	0.59	1.266	1.75	0.50	0.40
	T111724	E	0.548	0.704	3.44	1.88	0.59	1.266	1.75	0.50	0.40

1 A/A = Pneumatic Air to Air. A/SR = Pneumatic Air to Spring Return (fail-safe). E = Electric (motor driven).

2 No adapter plate is used with this coupling. J represents distance above reference point Y (top of mount bracket).

The same mounting kits, including fastener hardware and drive couplings, used for factory assembly are available for field assembly of Chemtrol® actuation equipment to installed valves. Recognizing that some facilities specify Chemtrol® Butterfly Valves while standardizing on other actuator brands, the use of Chemtrol® mount kits is required in these situations, and the critical data on this page are offered to facilitate adaptation.

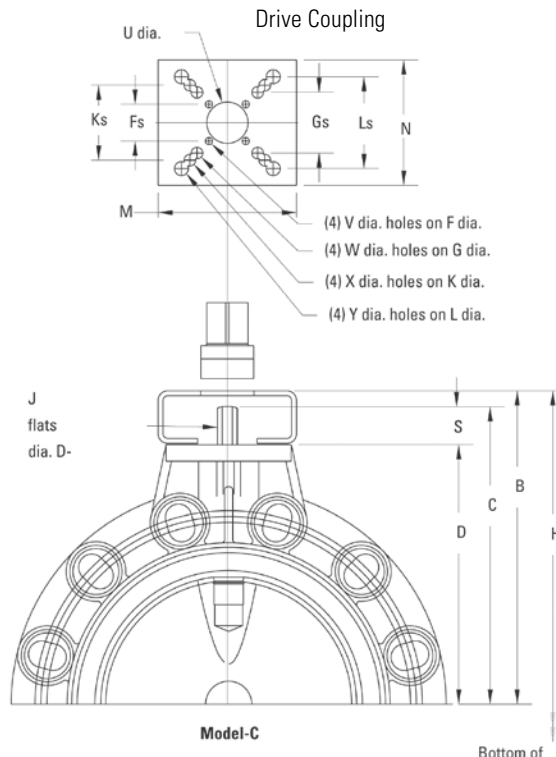
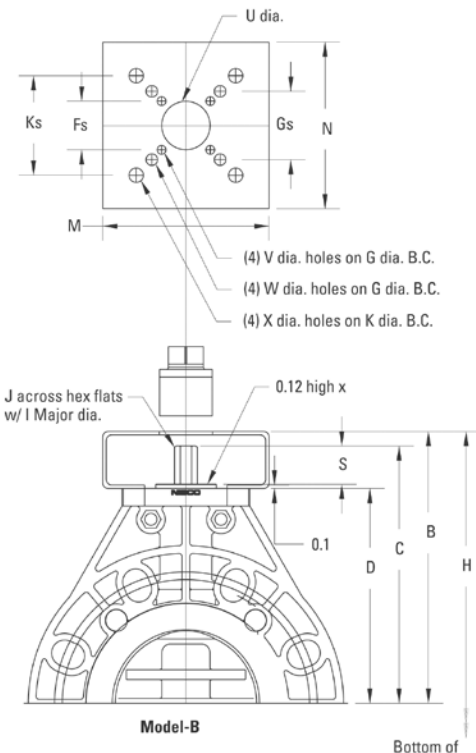
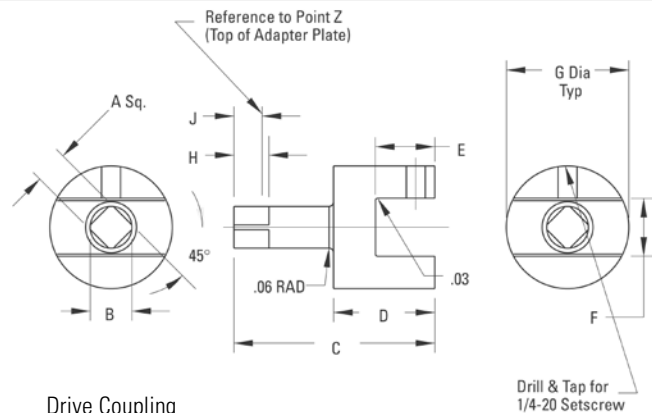

Actuator Mounting Data

Butterfly Valve Torques, Valve Mounting & Drive Coupling Dimensions and Mount Kit Part Numbers

Valve Model	Valve Size	Min. Torque (in. lbs.)	Valve Mounting Dimensions					Mount Kit Pt. #	Actuator Type ¹	Drive Coupling Dimensions									
			C	D	I Cir. Ø	J Flats	S			A Sq.	B Dia.	C	D	E	F	G Dia.	H	J Proj.	
Model B	3	400	6.00	4.75	0.51	0.37	1.13	T115706	A/A & E	0.549	0.697	1.95	1.30	1.03	0.374	1.50	0.50	0.45	
								T115709	A/SR	0.864	1.090	1.95	1.30	1.03	0.374	1.50	0.50	0.45	
	4	700	7.35	6.13	0.65	0.50	1.10	T115712	A/A	0.667	0.859	1.98	1.33	1.03	0.499	1.50	0.50	0.45	
								T115715	A/SR	0.864	1.090	1.98	1.33	1.03	0.499	1.50	0.50	0.45	
								T115718	E	0.549	0.697	1.98	1.33	1.04	0.566	1.50	0.50	0.45	
	6	1350	9.15	7.50	0.78	0.56	1.53	T115721	A/A	0.864	1.090	2.66	2.00	1.40	0.563	1.75	0.50	0.45	
T115724								A/SR	1.061	1.365	2.90	2.00	1.40	0.563	1.75	0.75	0.70		
T115727								E	0.549	0.697	2.91	2.26	1.66	0.879	1.75	0.50	0.45		
Model C	2	224	5.19	3.94	0.50	0.37	1.25	T111712	A/A	0.430	0.540	1.26	0.70	0.53	0.376	1.00	0.50	0.35	
								T111571	A/SR & E	0.548	0.692	1.44	0.75	0.53	0.376	1.25	0.63	0.53	
	2 1/2	285	5.38	4.13	0.50	0.37	1.25	T111712	A/A	0.430	0.540	1.26	0.70	0.53	0.376	1.00	0.50	0.35	
								T111578	A/SR	0.666	0.854	1.56	0.75	0.53	0.376	1.25	0.75	0.65	
								T111571	E	0.548	0.692	1.44	0.75	0.53	0.376	1.25	0.63	0.53	
	3	337	5.58	4.43	0.50	0.37	1.15	T111571	A/A & E	0.548	0.692	1.44	0.75	0.53	0.376	1.25	0.63	0.43	
								T111578	A/SR	0.666	0.854	1.56	0.75	0.53	0.376	1.25	0.75	0.55	
	4	420	6.56	5.31	0.65	0.50	1.25	T111714	A/A & E	0.548	0.692	1.44	0.75	0.53	0.501	1.25	0.63	0.53	
								T111574	A/SR	0.666	0.854	1.56	0.75	0.53	0.501	1.25	0.75	0.65	
	6	1261	8.34	7.09	0.78	0.56	1.25	T111576	A/A	0.863	1.085	2.13	1.13	0.66	0.565	1.25	0.88	0.72	
								T111703	A/SR	1.060	1.390	2.31	1.00	0.56	0.565	1.50	1.19	1.00	
								T111715	E	0.666	0.854	1.54	0.73	0.53	0.565	1.25	0.75	0.63	
	8	1901	9.25	8.00	0.78	0.56	1.25	T111576	A/A	0.863	1.085	2.13	1.13	0.66	0.565	1.25	0.88	0.72	
								T111703	A/SR	1.060	1.390	2.31	1.00	0.56	0.565	1.50	1.19	1.00	
T111400								E	1/4" key	1.373	3.25	1.37	0.94	0.565	1.50	1.63	1.56		
10	2595	11.09	9.84	1.06	0.75	1.25	T111717	A/A	0.863	1.085	2.25	1.25	0.75	0.753	1.50	0.88	0.75		
							T111705	A/SR	1.413	1.862	2.88	1.25	0.75	0.753	2.00	1.56	1.25		
							T111397	E	1/4" key	1.370	3.31	1.37	1.00	0.754	1.75	1.63	1.56		

¹A/A = Pneumatic Air to Air. A/SR = Pneumatic Air to Spring Return (fail-safe). E = Electric (motor driven).

Butterfly Valve Mount Bracket Dimensions

Valve Model	Valve Size	Mount Kit Pt #	Actuator Type ¹	B	F		G		H	K		L		M	N	U Dia.	V Dia.	W Dia.	X Dia.	Y Dia.
					B. C.	Sq.	B. C.	Sq.		B. C.	Sq.	B. C.	Sq.							
Model B	3	All	A/A, A/SR & E	6.40	1.97	1.39	2.76	1.95	10.15	4.02	2.84	-	-	4.75	4.75	1.38	0.25	0.33	0.41	-
	4	All	A/A, A/SR & E	7.78	1.97	1.39	2.76	1.95	11.28	4.02	2.84	-	-	4.75	4.75	1.38	0.25	0.33	0.41	-
	6	All	A/A, A/SR & E	10.08	1.97	1.39	4.02	2.84	15.58	4.92	3.48	-	-	4.75	4.75	1.38	0.25	0.41	0.48	-
Model C	2	T111712	A/A	5.57	1.42	1.00	1.65	1.17	8.86	3.25	2.30	-	-	3.25	3.25	1.06	0.20	0.20	0.44	-
		T111571	A/SR & E	5.57	1.97	1.39	2.76	1.95	8.86	-	-	-	-	3.50	3.25	1.44	0.27	0.34	-	-
	2 1/2	T111712	A/A	5.76	1.42	1.00	1.65	1.17	9.39	3.25	2.30	-	-	3.25	3.25	1.06	0.20	0.20	0.44	-
		Others	A/SR & E	5.76	1.97	1.39	2.76	1.95	9.39	-	-	-	-	3.50	3.25	1.44	0.27	0.34	-	-
	3	All	A/A, A/SR & E	6.06	1.97	1.39	2.76	1.95	9.97	-	-	-	-	3.50	3.25	1.44	0.27	0.34	-	-
	4	All	A/A, A/SR & E	6.94	1.97	1.39	2.76	1.95	11.51	-	-	-	-	3.50	3.25	1.44	0.27	0.34	-	-
		Others	A/A & A/SR	9.09	3.25	2.30	4.02	2.84	14.73	4.92	3.48	-	-	4.53	4.75	1.75	0.44	0.44	0.53	-
	6	T111715	E	8.72	1.97	1.39	2.76	1.95	14.36	-	-	-	-	3.50	3.25	1.44	0.27	0.34	-	-
		Others	A/A, A/SR & E	10.00	3.25	2.30	4.02	2.84	16.83	4.92	3.48	-	-	4.53	4.75	1.75	0.44	0.44	0.53	-
	10	Others	A/A & E	11.84	1.97	1.39	3.25	2.30	20.24	4.02	2.84	4.92	3.48	5.25	4.75	1.56	0.27	0.44	0.44	0.53
T111705		A/SR	11.97	5.00	3.54	5.51	3.90	20.37	-	-	-	-	5.75	5.75	2.09	0.56	0.69	-	-	

¹A/A = Pneumatic Air to Air. A/SR = Pneumatic Air to Spring Return (fail-safe). E = Electric (motor driven).

Metric Equivalent Charts

Linear Conversion Table From Fractional Inches to Millimeters

inches		mm	inches		mm
1/64	.016	.397	33/64	.516	13.097
1/32	.031	.794	17/32	.531	13.494
3/64	.047	1.191	35/64	.547	13.891
1/16	.063	1.588	9/16	.563	14.288
5/64	.078	1.984	37/64	.578	14.684
3/32	.094	2.381	19/32	.594	15.081
7/64	.109	2.778	39/64	.609	15.478
1/8	.125	3.175	5/8	.625	15.875
9/64	.141	3.572	41/64	.641	16.272
5/32	.156	3.969	21/32	.656	16.669
11/64	.172	4.366	43/64	.672	17.066
3/16	.188	4.763	11/16	.688	17.463
13/64	.203	5.159	45/64	.703	17.859
7/32	.219	5.556	23/32	.719	18.256
15/64	.234	5.953	47/64	.734	18.653
1/4	.250	6.350	3/4	.750	19.050
17/64	.266	6.747	49/64	.766	19.447
9/32	.281	7.144	25/32	.781	19.844
19/64	.297	7.541	51/64	.797	20.241
5/16	.313	7.938	13/16	.813	20.638
21/64	.328	8.334	53/64	.828	21.034
11/32	.344	8.731	27/32	.844	21.431
23/64	.359	9.128	55/64	.859	21.828
3/8	.375	9.525	7/8	.875	22.225
25/64	.391	9.922	57/64	.891	22.622
13/32	.406	10.319	29/32	.906	23.019
27/64	.422	10.716	59/64	.922	23.416
7/16	.438	11.113	15/16	.938	23.813
29/64	.453	11.509	61/64	.953	24.209
15/32	.469	11.906	31/32	.969	24.606
31/64	.484	12.303	63/64	.984	25.003
1/2	.500	12.700	1	1.000	25.400

1 inch = 25.4 millimeters

English to Metric Conversion Table

Units	Change to	Multiply by
Inches	Millimeters	25.40
Inches	Centimeters	2.54
Inches	Meters	.0254
Feet	Meters	.3048
Miles	Kilometers	1.609347
Sq. Inches	Sq. Centimeters	6.452
Sq. Feet	Sq. Meters	.0929
Cu. Inches	Cu. Centimeters	16.3872
Cu. Feet	Cu. Meters	.02832
U.S. Gallons	Liters	3.7854
Pounds	Kilograms	.45359

Metric to English Conversion Table

Units	Change to	Multiply by
Millimeters	Inches	.03937
Centimeters	Inches	.39371
Meters	Inches	39.371
Meters	Feet	3.281
Kilometers	Miles	.62137
Sq. Centimeters	Sq. Inches	.1550
Sq. Meters	Sq. Feet	10.7649
Cu. Centimeters	Cu. Inches	.061
Cu. Meters	Cu. Feet	35.314
Liters	U.S. Gallons	.26417
Kilograms	Pounds	2.20462

Physical Properties of Thermoplastic Piping Materials

ASTM Test Methods	Properties	Material			
		PVC 12454-B	CPVC 23447-B	PVDF	Polypropylene
General					
D792	Specific Gravity	1.38	1.50	1.76	.905
D570	Water Absorption % 24 Hrs. @ 73°F	.05	.05	.04	.02
Mechanical					
D638	Tensile Strength psi @ 73°F	7,300	7,200	6,000	4,600
D638	Modulus of Elasticity in Tension psi @ 73°F x 10 ⁵	4.2	3.7	2.1	2.0
D790	Flexural Strength psi	14,500	15,600	9,700	7,000
D256	Izod Impact Strength @ 73°F (Notched)	1.1	2.0	3.8	.8
Thermal					
D696	Coefficient of Thermal Expansion in/in/°F x 10 ⁻⁵	3.0	3.8	7.9	5.0
C177	Thermal Conductivity BTU/HR/Sq. Ft./°F/in	1.2	.95	.79	1.2
D648	Heat Distortion Temp. °F @ 66 psi	NA	NA	284	195
D648	Heat Distortion Temp. °F @ 264 psi	163	212	194	140
	Resistance to Heat °F at Continuous Drainage	140	210	280	180
Flammability					
D2863	Limiting Oxygen Index (%)	43	60	44	17
E84	Flame Spread	< 25	< 25	< 25	NA
E84	Smoke Generation Underwriters Lab Rating (Sub. 94)	> 250 94V-0	< 250 94V-0	< 50 94V-0	> 450 94HB

Dimensions and Reference

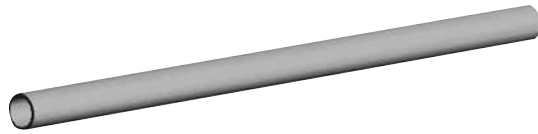

Pipe¹ 20 ft. Lengths

Nominal Pipe Size	Approximate Weight per 100 ft.				Nom. Outside Diameter (In.)	Nom. Inside Diameter (In.)	Wall Thickness (in.)		Cross-sectional Area (in. ²)	Internal Area (in. ²)	Fluid Capacity (gal/100ft.)	Outside Surf. Area (ft ² /100ft)	Threshold Flow ² (GPM)
	PVC	CPVC	Polypropylene	PVDF			Nom.	Min.					
1/4	10.1	11.9	—	—	.540	.282	.129	.119	.167	.062	.32	14.14	.97
1/2	20.5	24.3	14.0	24.4	.840	.526	.157	.147	.337	.217	1.13	21.99	3.39
3/4	27.8	32.9	18.9	33.0	1.050	.722	.164	.154	.457	.409	2.13	27.49	6.38
1	40.4	48.5	27.1	48.7	1.315	.936	.1895	.179	.670	.688	3.57	34.43	10.72
1 1/4	56.7	66.9	37.9	—	1.660	1.255	.2025	.191	.927	1.237	6.43	43.46	19.28
1 1/2	68.9	81.1	44.8	81.4	1.900	1.476	.212	.200	1.124	1.711	8.89	49.74	26.67
2	94.9	108.5	62.3	112.6	2.375	1.913	.231	.218	1.556	2.874	14.93	62.18	44.79
2 1/2	144.9	165.4	—	—	2.875	2.290	.2925	.276	2.373	4.119	21.40	75.27	64.19
3	193.8	221.3	126.6	256.4	3.500	2.864	.318	.300	3.179	6.442	33.47	91.63	100.40
4	283.3	323.4	185.2	357.0	4.500	3.786	.357	.337	4.647	11.258	58.48	117.81	175.44
6	541.1	616.8	359.9	714.3	6.625	5.709	.458	.432	8.873	25.598	132.98	173.44	398.93
8	821.9	905.8	—	—	8.625	7.565	.530	.500	13.479	44.948	233.49	225.80	700.48
10	1227.7	—	—	—	10.750	9.493	.6285	.593	19.985	70.778	367.68	281.43	1103.02
12	1710.4	—	—	—	12.750	11.294	.726	.687	27.495	100.181	520.79	333.79	1562.36

1 Dimensions shown are listed in ASTM D1785 and F441 for PVC and CPVC Schedule 80 plastic pipe, respectively.

2 Upper threshold rate of flow = 5 ft./sec. fluid velocity.

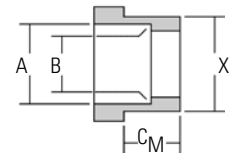
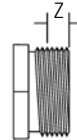
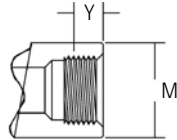
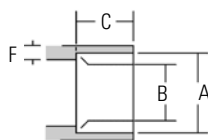

Fittings¹

Size	IPS Dia	Solvent Socket (S)			Female Threads (FPT)		Male Threads (MPT)	Male End (SPG)		Wall Thickness	
		A ³	B ³	C ⁴ Nom	Y ²	M ⁵ Min	Z ²	X	Cm ⁴ Nom	F ⁴ Min	E ⁴ Min
1/4	.540	.552	.536	.640	.311	.840	.311	.540	.655	.149	.119
1/2	.840	.848	.836	.890	.427	1.280	.427	.840	.905	.185	.147
3/4	1.050	1.058	1.046	1.015	.446	1.500	.446	1.050	1.030	.195	.154
1	1.315	1.325	1.310	1.140	.530	1.810	.530	1.315	1.155	.225	.179
1 1/4	1.660	1.670	1.655	1.265	.550	2.200	.550	1.660	1.280	.240	.191
1 1/2	1.900	1.912	1.894	1.390	.550	2.500	.550	1.900	1.405	.250	.200
2	2.375	2.387	2.369	1.515	.566	2.375	.566	2.375	1.530	.275	.218
2 1/2	2.875	2.889	2.868	1.780	.870	3.560	.870	2.875	1.810	.345	.276
3	3.500	3.516	3.492	1.905	.954	4.300	.954	3.500	1.933	.375	.300
4	4.500	4.518	4.491	2.280	1.032	5.430	1.032	4.500	2.310	.420	.337
6	6.625	6.647	6.614	3.030	—	—	—	6.625	3.060	.540	.432
8	8.625	8.655	8.610	4.500	—	—	—	8.625	4.590	.625	.500
10	10.750	10.780	10.735	5.500	—	—	—	10.750	5.590	.741	.593
12	12.750	12.780	12.735	6.500	—	—	—	12.750	6.590	.859	.687

1 With exception of thread lengths, dimensions shown are listed in ASTM D2467 and F439 for PVC and CPVC socket-type Schedule 80 fittings, respectively.

2 Dimensions shown are typical male component engagement, hand-tight (L_t in ANSI B1.20.1 thread spec.) plus 1 1/2 turns lightening.

3 Dimensions shown are not applicable for polypropylene or PVDF. Socket diameters in these materials are designed for Chemtrol® thermo-seal socket fusion joining.

4 Chemtrol® fittings may exceed certain minimum ASTM dimensional requirements in order to ensure functional satisfaction.

5 Dimensions are listed in ASTM D2464 and F437 for PVC and CPVC threaded Schedule 80 fittings, respectively.

WARNING: DO NOT USE OR TEST THE PRODUCTS IN THIS CATALOG WITH COMPRESSED AIR OR OTHER GASES. FAILURE TO FOLLOW THIS WARNING CAN RESULT IN PERSONAL INJURY OR DAMAGE TO PROPERTY.

Dimensions and References

National (American) Standard Taper Pipe Thread, NPT (excerpt from ANSI B1.20.1)

Nominal Size	Outside Diameter D	Number of Threads Per Inch n	Pitch of Thread p	Normal Engagement By Hand L ₁	Length of Effective Thread L ₂	Wrench Makeup Length for Internal Thread L ₃	Total Length: End of Pipe to Vanish Point L ₄	Pitch Diameter at Beginning of External Thread E ₀	Pitch Diameter at Beginning of Internal Thread E ₁	Height of Thread (Max.) h
in.	in.		in.	in.	in.	in.	in.	in.	in.	in.
1/4	0.540	18	.05556	.228	.4018	.1667	.5946	.47739	.49163	.04444
1/2	0.840	14	.07143	.320	.5337	.2143	.7815	.75843	.77843	.05714
3/4	1.050	14	.07143	.339	.5457	.2143	.7935	.96768	.98887	.05714
1	1.315	11 1/2	.08696	.400	.6828	.2609	.9845	1.21363	1.23863	.06957
1 1/4	1.660	11 1/2	.08696	.420	.7068	.2609	1.0085	1.55713	1.58338	.06957
1 1/2	1.900	11 1/2	.08696	.420	.7235	.2609	1.0252	1.79609	1.82234	.06957
2	2.375	11 1/2	.08696	.436	.7565	.2609	1.0582	2.26902	2.29627	.06957
2 1/2	2.875	8	.12500	.682	1.1375	.2500	1.5712	2.71953	2.76216	.10000
3	3.500	8	.12500	.766	1.2000	.2500	1.6337	3.34062	3.38850	.10000
4	4.500	8	.12500	.844	1.3000	.2500	1.7337	4.33438	4.38712	.10000

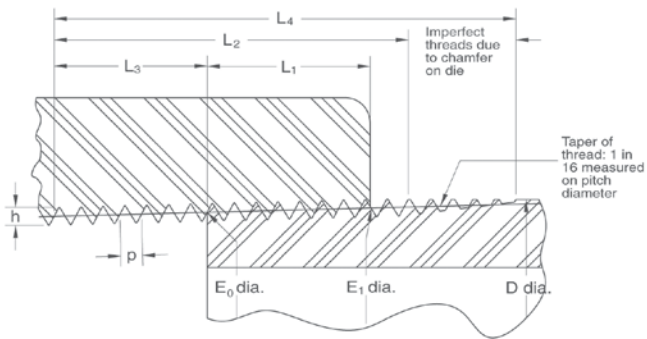

Do not thread Schedule 40 pipe.

Pressure Factors

Pressure measurements are based on the standardized weight of water expressed in a variety of English and metric units.

1 psig (gauge)	=	2.3068	foot of water head
	=	2.036	inch of mercury head
	=	0.0689	bar
	=	0.0703	kgm/cm ² (kilograms/centimeter ²)
	=	6894.757	N/m ² (newton/meter ²)
	=	6.8948	kPa (kilopascal)
1 foot of water	=	0.4335	psig
	=	0.0305	kgm/cm ² (kilograms/centimeter ²)
	=	2988.8837	N/m ² (newton/meter ²)
	=	0.33457	kPa (kilopascal)
	=	0.02989	bar
1 bar	=	100000.0	N/m ² (newton/meter ²)
	=	14.50377	psig
	=	100.0	kPa (kilopascal)
	=	10197.1621	kgm/cm ² (kilograms/centimeter ²)
	=	33.456	foot of water head
1 N/m ² (newton/meter ²)	=	1.0	Pa (pascal) = 0.001 kPa (kilopascal)
	=	0.000010197	kgm/cm ²
	=	0.000145	psig (gauge)
1 kilogram/centimeter ²	=	98066.5	N/m ² (newton/meter ²)
	=	14.2233	psig

ANSI B16.5 Dimensional Data – Flanges and Flanged Fittings

Nominal Pipe Size (In.)	Outside Diameter (In.)	Number of Holes	Drilling	
			Diameter of Bolt (In.)	Diameter of Bolt Circle (In.)
1/2	3.50	4	1/2	2.38
3/4	3.88	4	1/2	2.75
1	4.25	4	1/2	3.12
1 1/4	4.62	4	1/2	3.50
1 1/2	5.00	4	1/2	3.88
2	6.00	4	5/8	4.75
2 1/2	7.00	4	5/8	5.50
3	7.50	4	5/8	6.00
4	9.00	8	5/8	7.50
6	11.00	8	3/4	9.50
8	13.50	8	3/4	11.75
10	16.00	12	7/8	14.25
12	19.00	12	7/8	17.00

† Dimensions and bolts conform to ANSI B16.5 for 150 lb. steel flanges. Bolt holes are 1/8" larger in diameter than the required bolts.

Vacuum Factors

Vacuum may be thought of as the absence of pressure. It is the measure of negative pressure between standardized atmospheric pressure and a theoretically perfect vacuum.

1 Std. Atmosphere	=	14.6959	psia (absolute)
	=	760.0	mm (millimeter) of mercury head
	=	1.0332276	kgm/cm ² (kilograms/centimeter ²)
	=	1.01325	bar
	=	101.325	kPa (kilopascal)
1 mm	=	0.03937	inch
1 micron of mercury	=	0.001	mm (millimeter) of mercury head
	=	0.000019336	psig (gauge)
1 mm of mercury	=	1000.0	micron of mercury head
1 inch	=	25.4	mm (millimeter)
1 inch of mercury	=	25400.0	micron of mercury head
	=	0.4912	psig
1 inch of water	=	0.0361	psig
	=	1868.2742	micron of mercury head
1 psig (gauge)	=	27.6817	inch of water head

Pressure Ratings of Chemtrol Products

Pipe and Fittings

In order to determine the pressure rating for product system, first find the plastic material and schedule (wall thickness—see Reference Data—Schedule 80 components for additional information) of pipe and fittings in the heading of the Maximum Nonshock Operating Pressure table below. Then, locate the selected joining method in the subheading of the table and go down the column to the value across from a particular pipe size, listed in the far left column. This will be the maximum non-shock operating pressure at 73° F for the defined product system.

Maximum Nonshock Operating Pressure (psi) at 73° F¹

Nom. Pipe Size	Schedule 40		Schedule 80		Schedule 80		Schedule 80	
	PVC & CPVC	PVC & CPVC	Polypropylene	Polypropylene	PVDF (Kynar®)	PVDF (Kynar®)	PVDF (Kynar®)	PVDF (Kynar®)
	Socket End	Socket End	Threaded End	Thermo-Seal Joint	Threaded ³ End	Thermo-Seal Joint	Threaded End	
1/2	600	850	420	410	20	580	290	
3/4	480	690	340	330	20	470	230	
1	450	630	320	310	20	430	210	
1 1/4	370	520	260	260	20	-----	-----	
1 1/2	330	470	240	230	20	326	160	
2	280	400	200	200	20	270	140	
2 1/2	300	420	210	-----	-----	-----	-----	
3	260	370	190	190	20	250	N.R.	
4	220	320	160	160	20	220	N.R.	
6	180	280	N.R.	140	N.R.	190	N.R.	
8	160	250 ²	N.R.	-----	-----	-----	-----	
10	140	230	N.R.	-----	-----	-----	-----	
12	130	230	N.R.	-----	-----	-----	-----	

- For more severe service, an additional correction factor may be required.
 - 8° CPVC Tee, 90° ELL and 45° ELL rated at 1/2 of value shown.
 - Recommended for intermittent drainage pressure not exceeding 20 psi. Not available in natural polypropylene.
- N.R. Not Recommended and NOT WARRANTED by manufacturer.

As implied by the preceding, the pressure for all thermoplastic piping is a function of temperature. For pipe and fitting applications above 73° F, refer to the table at the top of the next column for the Temperature Correction Factors. To determine the maximum non-shock pressure rating at an elevated temperature, simply multiply the base pressure rating obtained from the upper table by the correction factor from the upper table in the next column. Below 73° F the pressure rating will be the same as the base pressure in the table above.

Temperature Correction Factors

Operating Temperature (° F)	Factors			
	PVC	CPVC	PP	Kynar® PVDF
70	1.00	1.00	1.00	1.00
80	0.90	0.96	0.97	0.95
90	0.75	0.92	0.91	0.87
100	0.62	0.85	0.85	0.80
110	0.50	0.77	0.80	0.75
115	0.45	0.74	0.77	0.71
120	0.40	0.70	0.75	0.68
125	0.35	0.66	0.71	0.66
130	0.30	0.62	0.68	0.62
140	0.22	0.55	0.65	0.58
150	N.R.	0.47	0.57	0.52
160	N.R.	0.40	0.50	0.49
170	N.R.	0.32	0.26	0.45
180	N.R.	0.25	*	0.42
200	N.R.	0.18	N.R.	0.36
210	N.R.	0.15	N.R.	0.33
240	N.R.	N.R.	N.R.	0.25
280	N.R.	N.R.	N.R.	0.18

* Recommended for intermittent drainage pressure not exceeding 20 psi. N.R. Not Recommended and NOT WARRANTED by manufacturer.

Temperature Conversion

$$F = C \times 1.8 + 32 \quad C = (F - 32) \div 1.8$$

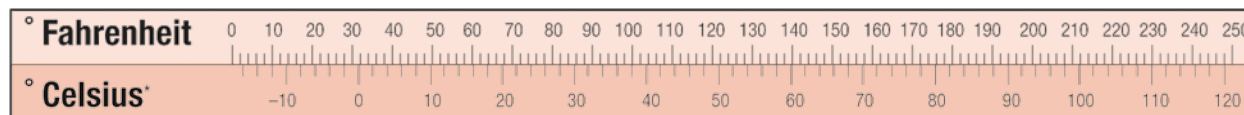

* Formerly known as Centigrade

Kynar® is a registered trademark of Arkema Inc.

Pressure Ratings of Chemtrol Products

Valves, Unions, and Flanges

As with all other thermoplastic piping components, the maximum pressure rating for all Chemtrol® valves, unions and flanges, regardless of size, is related to temperature as per the chart below.

Operating Temperature (° F)	Model D Ball Valve		All Other Valves, Unions & Flanges			
	PVC	CPVC	PVC	CPVC	PP	PVDF
70	250	250	150	150	150	150
80	250	250	150	150	150	150
90	225	250	150	150	150	150
100	200	240	150	150	150	150
110	180	220	135	140	140	150
120	165	190	125	130	130	150
130	140	180	110	120	118	150
140	130	170	50	110	105	150
150	N.R.	160	N.R.	100	93	140
160	N.R.	150	N.R.	90	80	133
170	N.R.	140	N.R.	80	70	125
180	N.R.	130	N.R.	70	50	115
200	N.R.	65	N.R.	50	N.R.	97
210	N.R.	30	N.R.	25	N.R.	85
220	N.R.	N.R.	N.R.	N.R.	N.R.	75
240	N.R.	N.R.	N.R.	N.R.	N.R.	55
260	N.R.	N.R.	N.R.	N.R.	N.R.	40
280	N.R.	N.R.	N.R.	N.R.	N.R.	25

N.R. Not Recommended and NOT WARRANTED by manufacturer.

Chemtrol Valve Construction and Performance Standards

For over 55 years, the construction and performance standards on plastic valves have traditionally been set by Chemtrol products for the industry to follow. Specifying engineers should know that:

1. Chemtrol® valves are 100% seat and shell tested.
2. The sockets of PVC and CPVC Chemtrol valves conform to the dimensional requirements of ASTM Standards D2467 (PVC) and F439 (CPVC) for Schedule 80 Socket pressure fittings. For dimensional details please reference the data on the preceding pages.
3. The threaded end connections of all Chemtrol valves meet ANSI B1.20.1 (was ASA B2.1) requirements for National (American) Standard Pipe Taper Pipe Threads and conform to the dimensional requirements of ASTM Standards D2464 (PVC) and F437 (CPVC) for Schedule 80 Threaded pressure fittings.
4. The flanges attached to all Chemtrol valves meet the outside diameter and bolt hole requirements of ANSI B16.5 for 150 lb. Steel Pipe Flanges.
5. The physical and chemical properties of PVC and CPVC are classified and grouped into characteristic materials by ASTM Standard D1784. The materials, used in domestically produced Chemtrol Valves, exceed the rigid requirements set forth for cell class 12454 (PVC) and 23447 (CPVC). These are the respective materials stipulated for use in pipes which merit the highest Hydrostatic Design Stress rating (2000 psi) and the maximum corrosion resistance.
6. Independent third party tested and certified PVC and CPVC Chemtrol Valves are regularly tested for compliance with NSF/ANSI 14 "Plastic Piping System Components and Related Materials" requirements establishing minimum physical, performance, and health effect requirements for the protection of public health and the environment.

Valve Pressure-Loss Calculations

As an aid to system design, fluid flow coefficients (C_v values) are shown for all Chemtrol valves. C_v is defined as the flow, in GPM, through a valve which will produce a pressure drop of 1.0 PSI when the medium is water at 60°F.

To determine the pressure drop for a given condition, the following formula may be used:

$$\Delta P = \frac{Q^2 S.G.}{C_v^2}$$

Where ΔP = Pressure drop across the valve in psi
 Q = Flow through the valve in gpm
 $S.G.$ = Specific gravity of the liquid (water = 1.0)
 C_v = Fluid flow coefficient

The solution of an example problem follows. Refer to the product description page in this Valve Guide for C_v values of specific valves.

Example

Find the pressure drop across a 1 1/2" Ball Check Valve with a water flow rate of 50 gpm.

The C_v for the Chemtrol® Check Valve is 56, as shown on page 17.

$$\Delta P = \frac{(50)^2 \times 1.0}{(56)^2}$$

$$\Delta P = \left(\frac{50^2}{56^2} \right)$$

$$\Delta P = .797 \text{ psi}$$

Many commercial, industrial, and governmental standards or specifications are available to assist the design engineer in specifying plastic piping systems. Standards most frequently referred to and most commonly called out in plastic piping specifications are ASTM Standards. These standards also often form the basis of other standards in existence. Below is a list and description of those standards most typically applied to industrial plastic piping.

ASTM D1784

(American Society for Testing and Materials)

This specification covers rigid PVC and CPVC compounds intended for general purpose use in extruded or molded form including pressure piping applications and nonpressure piping applications composed of poly(vinyl chloride), chlorinated poly(vinyl chloride), or vinyl chloride copolymers containing at least 80% vinyl chloride, and the necessary compounding ingredients.

ASTM D1785 and F441

These standards cover the specification and quality of Schedule 40, 80, and 120 PVC (D1785) and CPVC (F441) pressure pipe. Outlined in these standards are dimensional specifications, burst, sustained, and maximum operating pressure requirements and test procedures for determining pipe quality with respect to workmanship and materials.

ASTM D2466

This standard covers Schedule 40 PVC threaded and socket pressure fittings. Stipulated in the standard are thread and socket specifications, by lengths, wall thickness, burst, material, quality, and identification requirements.

ASTM D2467 and F439

These standards cover Schedule 80 PVC (D2467) and CPVC (F439) Socket Type and Threaded Pressure Fittings. Dimensions, burst strength, resin compound stipulation, and scheme of product identification requirements are specified.

ASTM D2564 and F493

These standards set forth requirements for PVC (D2564) and CPVC (F493) Solvent Cement. The specification identifies the resin compound to be used and stipulates minimum resin content, solution viscosities, and physical performance qualities.

ASTM F656

This specification covers requirements for primers for use with poly(vinyl chloride) (PVC) pipe and fittings that are to be joined by PVC solvent cements meeting the requirements of Specification.

ASTM F1970

This specification covers special engineered fittings or appurtenances for use in PVC or CPVC systems. Flanges, unions, and valves not included in the scope of other ASTM specifications are specifically referenced. Minimum requirements are identified for testing materials, dimensions, marking, and in-plant quality control.

ASTM F1498

This specification adapts the General Purpose American Pipe Thread Specification, ASME B1.20.1, to taper pipe threads for use on plastic pipe and fittings with machined or molded threads. The standard covers dimensions and gaging of plastic tapered National Pipe Threads (NPT) for leak-tight joints, and it is now referenced in all ASTM Standards for plastic piping products.

ASTM D2855

This standard describes the procedure for making joints with PVC pipe and fittings by means of solvent cementing.

ASTM D4101 (Formerly D2146)

This specification covers polypropylene materials suitable for injection molding and extrusion. Polymers consist of homopolymer, copolymers, and elastomer compounded with or without the addition of impact modifiers (ethylene-propylene rubber, polyisobutylene rubber, and butyl rubber), colorants, stabilizers, lubricants, or reinforcements.

ASTM D1599

This standard covers the test method for establishing the short-term hydraulic failure pressure of thermoplastic pipe, tubing, and fitting under specific temperature, time, and method of loading conditions. These test techniques are normally used for quality control.

ASTM D1598

This test method covers the determination of the time-to-failure of both thermoplastic and reinforced thermosetting/resin pipe under constant internal pressure.

ASTM D2837

This standard describes the procedure for obtaining the Hydrostatic Design Basis for all known thermoplastic pipe materials and for any practical temperature and medium. This was achieved by evaluating stress rupture data, taken from tests conforming to ASTM D1598, for the subject material and involved specified treatment and analysis of data.

ASTM D2657

This standard covers the procedure for heat-fusion bonding of polyolefin materials.

ASTM D3222

This standard covers the polymerization method and physical properties of PVDF (polyvinylidene fluoride) Fluoroplastic Materials for molding and extrusion.

Organizations other than ASTM issue standards that are commonly encountered in industrial thermoplastic piping design. The most common standards are described below.

ASME B1.20.1 (was B2.1)

This specification details the dimensions and tolerance for tapered pipe threads. This standard is referenced in the ASTM standards for threaded fittings mentioned above. See Reference Data for details.

ASME B16.5

This specification sets forth standards for bolt holes, bolt circles, and overall dimensions for steel 150# flanges. See Reference Data for details.

NSF/ANSI 14

The physical, performance, and health effects requirements in this Standard apply to thermoplastic and thermoset plastic piping system components, including but not limited to pipes, fittings, valves, joining materials, gaskets, and appurtenances. The established physical, performance, and health effects requirements also apply to materials (resin or blended compounds) and ingredients used to manufacture plastic piping system components. This Standard provides definitions and requirements for materials, ingredients, products, quality assurance, marking, and record keeping.

Fittings and valves made from copper alloys containing more than 15% zinc by weight shall be resistant to dezincification and stress corrosion cracking (SCC) and shall meet the test requirements of this standard.

NSF/ANSI 61

This Standard establishes minimum health effects requirements for the chemical contaminants and impurities that are indirectly imparted to drinking water from products, components, and materials used in drinking water systems. This Standard does not establish performance, taste and odor, or microbial growth support requirements for drinking water system products, components, or materials.

This Standard is intended to cover specific materials or products that come into contact with: drinking water, drinking water treatment chemicals, or both. The focus of the Standard is evaluation of contaminants or impurities imparted indirectly to drinking water. The products and materials covered include, but are not limited to, process media (e.g., carbon, sand), protective materials (e.g., coatings, linings, liners), joining and sealing materials (e.g., solvent cements, welding materials, gaskets), pipes and related products (e.g., pipes, tanks, fittings), mechanical devices used in treatment/transmission/distribution systems (e.g., valves, chlorinators, separation membranes, point-of-entry drinking water treatment systems), and mechanical plumbing devices (e.g., faucets, endpoint control valves).

Technical Service

Technical assistance regarding standards, applications, product performance, design, and installation tips is available from Technical Services Technical Information Hotline: (888) 446-4226 phone; (888) 336-4226 fax.

Polyvinyl Chloride (PVC) Schedule 80 Industrial Pipe and Fittings

Scope:

This specification establishes the manufacturing requirements for PVC Schedule 80 piping components intended for use in industrial, pressure-rated, fluid-handling systems for applications at 140° F or less, where resistance to corrosion is of prime importance.

Materials:

Pipe and fittings shall be manufactured from a PVC compound that meets the requirements of Cell Classification 12454 polyvinyl chloride as outlined in ASTM D1784. PVC shall be gray in color. Pipe and fitting materials shall be specifically formulated with sufficient UV stabilizers to provide for long-term outdoor exposure with no deleterious effects.

Materials from which pipe and fittings are manufactured shall have been tested and approved for conveying potable water by NSF International.

Dimensions/Design (IPS Size):

Socket-end connections shall have diameters, lengths, and wall thicknesses as required by ASTM D2467; taper pipe threaded-end connections shall have thread lengths, diameters, and configurations in conformance with ASTM D2467.

Fittings shall be industrial, heavy-duty, hub style.

Flanges shall be either a one-piece solid or a two-piece Van Stone design that utilizes the tapered, serrated-face and full-face gasket technique for joining and are compatible with ASME B16.5 Class 150 metal flanges.

Unions shall have an O-ring seal and components interchangeable with true union valves for maximum system versatility.

Transition unions, unions intended for joining dissimilar materials, shall utilize components of the two dissimilar materials, joined with an O-ring to absorb the thermal-expansion coefficient differential.

Pipe shall be as prescribed by ASTM D1785 for pressure-rated piping systems.

Pressure Ratings:

Socket fittings shall be rated at the same pressure as the corresponding size pipe prescribed by ASTM D1785. Threaded fittings shall be rated at 50% of the pressure rating of the corresponding size pipe prescribed by ASTM D1785.

Valves, unions, and flanges shall be rated at 150 psi for non-shock water service at 73° F and have a minimum 60 second burst requirement of 3.2 times the rated pressure.

Markings:

Fittings and pipe shall be clearly marked with the manufacturer's name or trademark, material designation, ASTM number or equivalent symbol indicating compliance with applicable standards, NSF International certification mark, NSF-pw, (verifying approval for the conveyance of potable water), and the country of manufacture.

Installation/Maintenance:

Installation and operation shall be as specified by the manufacturer's printed instructions.

Chlorinated Polyvinyl Chloride (CPVC) Schedule 80 Industrial Pipe and Fittings

Scope:

This specification establishes the manufacturing requirements for CPVC Schedule 80 piping components intended for use in industrial, pressure-rated, fluid-handling systems for applications at 210° F or less, where resistance to corrosion at elevated temperatures is of prime importance.

Materials:

Rigid CPVC (chlorinated polyvinyl chloride) used in the manufacture of Schedule 80 piping components shall be Cell Classification 23447 as identified in ASTM D1784. CPVC materials shall be light gray in color. Pipe and fitting materials shall be specifically formulated with sufficient UV stabilizers to provide for long-term outdoor exposure with no deleterious effects. CPVC material used to manufacture pipe and fittings shall be approved for the conveyance of potable water by a third-party certification agency.

Dimensions/Design (IPS Size):

Socket-end connections shall have diameters, lengths, and wall thicknesses as required by ASTM F439; taper pipe threaded-end connections shall have thread lengths, diameters, and configurations in conformance with ASTM F439.

Pipe shall have diameters and wall thicknesses in conformance with the requirements of ASTM F441.

Fittings shall be industrial, heavy-duty, hub style.

Flanges shall be either a one-piece design or a two-piece Van Stone design that utilizes the tapered, serrated-face and full-face gasket technique for joining and are compatible with ASME B16.5 Class 150 metal flanges.

Unions shall have an O-ring seal and components interchangeable with true union valves for maximum system versatility.

Transition unions, unions intended for joining dissimilar materials, shall utilize components of the two dissimilar materials, joined with an elastomeric seal to absorb the thermal-expansion coefficient differential.

Pressure Ratings:

Socket fittings shall be rated at the same pressure as the corresponding size pipe prescribed by ASTM F441. Threaded fittings shall be rated at 50% of the pressure rating as the corresponding size pipe prescribed by ASTM F441.

Valves, unions, and flanges shall be rated at 150 psi for non-shock water service at 73° F, and have a minimum 60 second burst requirement of 3.2 times the rated pressure.

Markings:

Fittings and pipe shall be clearly marked with the manufacturer's name or trademark, material designation, ASTM number or equivalent symbol indicating compliance with applicable standards, NSF International certification mark, NSF-pw, (verifying approval for the conveyance of potable water), and the country of manufacture.

Installation/Maintenance:

Installation and operation shall be as specified by the manufacturer's printed instructions.

250 PSI Tru-Bloc® True Union Ball Valves, Model D

Scope: This specification establishes the requirements for dual blocking (Tru-Bloc) quarter-turn ball valves of PVC and CPVC materials intended for use in industrial, commercial, and residential pressure-piping systems, where cost-effective, long-term resistance to corrosion is of prime importance, and the service temperature does not exceed: PVC, 140°F; CPVC, 210°F.

Major component parts shall be constructed from one of the following:

NPS ½" – 2" PVC (polyvinyl chloride), Cell Classification 12454 per ASTM D1784, industrial gray in color, and the valve shall be full-port Tru-Bloc.

NPS ½" – 2" Corzan® HP CPVC (Chlorinated polyvinyl chloride), Cell Class 23447 per ASTM D1784, industrial light-port gray in color, and the valve shall be full Tru-Bloc, with the material being pressure rated by an independent third party organization such as PPI (Plastic Piping Institute).

Standard Dimensions: PVC and CPVC socket-end connections shall conform to the dimensional requirements of ASTM D2467 (PVC) and F439 (CPVC) for Schedule 80 pressure fittings.

All threaded-end connections shall conform to the dimensional requirements of ASTM D2467 (PVC) and F439 (CPVC) as well as ASTM F1498.

Performance: Valves shall be rated for 250 psi non-shock water service at 73°F and have a minimum burst rating of 3.2 times rated working pressure.

PVC Valves shall be rated at 165 psi non-shock water service at 120°F, with a minimum burst rating of 3.2 times rated working pressure.

CPVC Valves shall be rated to 190 psi non-shock water service at 120°F and 130 psi at 180°F, with a minimum burst rating of 3.3 times rated working pressure.

Valves shall be certified to ASTM D1970 by a recognized third-party agency such as NSF International.

Markings: Valves shall be clearly marked with the manufacturer's name or trademark, nominal size, material designation, ASTM D1970, Country of origin, and bare the NSF-PW-G (verifying listings for conveying potable water, dezincification resistant, and lead-free).

Installation and Operation: Installation and operation shall be as specified by the manufacturer's printed instructions.

150 PSI Tru-Bloc® True Union Ball Valves, Model C

Scope:

This specification establishes the manufacturing requirements for dual-blocking (Tru-Bloc) and downstream-only blocking (true union) quarter-turn ball valves of PVC and CPVC materials intended for use in industrial, commercial, and residential pressure-piping systems, where cost-effective, long-term resistance to corrosion is of prime importance, and the service temperature does not exceed: PVC, 140° F; CPVC, 210° F.

Major component parts shall be constructed from one of the following:

NPS 3 – 6 PVC (polyvinyl chloride), Cell Class 12454 per ASTM D1784, industrial gray in color, and the valve style shall be full-port Tru-Bloc, TU (NPS 6 is standard port).

NPS 3 – 6 CPVC (chlorinated polyvinyl chloride), Cell Class 23447 per ASTM D1784, industrial light gray, and the valve style shall be full-port Tru-Bloc, TU (NPS 6 is standard port)

Dimensions/Valve Design:

PVC and CPVC socket-end connections shall conform to the requirements of ASTM D2467 and F439 for Schedule 80 pressure fittings.

All threaded-end connections shall conform to the requirements of ASTM D2467 and F439 as well as ASTM F1498 for tapered pipe threads.

Performance:

Valves shall be rated for 150 psi non-shock water service at 73° F water and have a minimum burst rating of 3.2 times the rated working pressure. Valves shall be certified to ASTM F1970 by a third-party agency.

Markings:

Valves shall be clearly marked with the manufacturer's name or trademark, nominal size, material designation, ASTM number or equivalent symbol indicating compliance with applicable standards, and country of manufacture. PVC and CPVC valves shall additionally bear the NSF International certification mark, NSF-pw, (verifying approval for conveyance of potable water).

Installation:

Installation and operation shall be as specified by the manufacturer's printed instructions.

Vented (Bleach) Ball Valves, True Union

Recommended Specification

In the interest of safety, owners of sodium hypochlorite transfer and injection piping systems must have confidence that the PVC or CPVC ball valves in their system were properly manufactured, cleaned, assembled, tested, and oriented during installation in accordance with intended system design. Therefore, engineering specifications for bleach transfer and injection systems should include the following product, installation, and pre-commissioning inspection requirements:

- All PVC or CPVC vented ball valves must be of the True Union type with an energized seat that will concurrently provide automatic adjustment for wear and leak-free service at the lower pressure port. And the ball must contain an adequate vent to the pressure port opposite of the downstream sealing port.
- The manufacturer of all PVC or CPVC vented ball valves must complete all components prior to the factory assembly, test, and packaging of those valves. Modification of assembled valves by any manufacturer or vendor is unacceptable. Also, the valves must be individually packaged with each carton label stating: Vented ball valve, size, material, and manufacturer.
- Vented ball valves must be permanently marked externally with: the word Bleach; two opposing directional arrows, one inscribed with Flow and other with Vent; and the NSF certification mark.

150 PSI Ball Check and Foot Valves

Scope:

This specification establishes the manufacturing requirements for PVC and CPVC ball check and foot valves intended for use in industrial, commercial, and residential pressure-piping systems, where cost-effective, long-term resistance to corrosion is of prime importance. Maximum service temperatures are: PVC, 140° F; CPVC, 210° F.

Materials:

Major component parts shall be constructed from one of the following:

NPS 1/2 – 4 PVC (polyvinyl chloride), Cell Class 12454 per ASTM D1784, industrial gray in color.

NPS 1/2 – 4 CPVC (chlorinated polyvinyl chloride), Cell Class 23447 per ASTM D1784, industrial light gray in color.

Dimensions/Valve Design:

PVC and CPVC socket-end connections shall conform to the requirements of ASTM D2467 and F439 for Schedule 80 pressure fittings. All threaded-end connections shall conform to the requirements of ASTM D2467 and F439 as well as ASTM F1498 for tapered pipe threads.

The valve design shall be full port (NPS 4 size is standard port) with full flow around the rib-guided ball. Foot valve models shall have a minimum cumulative-area ratio of screen holes (inlet)-to-valve port of 3:1.

The valve seat shall be an elastomeric seal that will permit seating at low-head pressure, and an arrow shall be molded on the valve body for permanent visibility to indicate the intended direction of flow.

Markings:

Valves shall be clearly marked with the manufacturer's name or trademark, nominal size, material designation, ASTM number or equivalent symbol indicating compliance with applicable standards, and country of manufacture. PVC and CPVC valves shall additionally bear the NSF International certification mark NSF-pw, (verifying approval for conveyance of potable water).

Performance:

Valves shall be rated for 150 psi service at 73° F non-shock water service and have a minimum burst rating of 3.2 times the rated working pressure. Valves shall be certified to ASTM F1970 by a third-party agency.

Installation:

Installation and operation shall be as specified by the manufacturer's printed instructions.

150 PSI Model B Wafer Style Butterfly Valves

Scope:

This specification establishes the manufacturing requirements for PVC and CPVC, Butterfly Valves intended for use in industrial, commercial, and residential pressure-piping systems for service temperatures that do not exceed 140° F for PVC systems or 210° F for CPVC systems, where resistance to corrosion is of prime importance does not.

Materials (PVC NPS 4 & 6, CPVC 3):

The body and disc shall be manufactured from a PVC or CPVC compound that meets the requirements of Cell Class 12454 polyvinyl chloride or Cell Class 23447 chlorinated polyvinyl chloride as outlined in ASTM D1784.

The shaft shall be cadmium-plated steel alloy or 316 stainless steel as standard equipment. Optional shaft materials shall be available on request, i.e., titanium, stainless steel, etc.

The seat material shall be one of the following materials: ethylene-propylene-diene monomer (EPDM) or fluoroelastomer (FKM) with polytetrafluoroethylene (PTFE) bearing support at the top and bottom.

Bearings shall be corrosion-resistant, 20% glass-filled PTFE.

Secondary seal material shall be FKM or EPDM and correspond to the seat material for maximum chemical resistance.

Handles and worm-gear operators shall be of a contrasting color with corrosion-resistant epoxy coating per manufacturer's Engineering Specifications #AP00307002A.

Valve Design:

The valve body shall be of the wafer design for ease of installation and maintenance and shall be compatible with Class 150 ASME B16.5 flanges. Nominal sizes 3 through 6 shall also be compatible with DIN 8063 pattern.

The shaft shall be hexagonal or square to ensure positive rotation of the disc and be totally sealed from exposure to the process liquid.

The shaft shall be guided by glass-filled PTFE bearings to protect against deflection. The shaft also shall have a directional indicator on top to indicate disc position when the handle is removed.

Markings:

Valves shall be clearly marked with the manufacturer's name or trademark, nominal size, material designation, and country of manufacture. PVC and CPVC valves shall additionally bear the NSF International certification mark, NSF-pw, (verifying approval for conveyance of potable water).

Performance:

Valves shall be rated bubble-tight at 150 psi 73° F non-shock water service except NPS 6 size shall be de-rated by 25%. The pressure rating shall be based on a minimum safety factor of 3.2.

Operation:

Valves shall be supplied by the manufacturer with one of the following:

- | | |
|----------------------------------|--|
| a. Lever handle with index plate | e. 2" Square Operator Nut |
| b. Worm-Gear Operator | f. 2" Locking Type Square Operator Nut |
| c. Pneumatic Operator | g. Lockable Lever Handle |
| d. Electric Operator | h. Other Manual Accessories |

Installation:

Installation and operation shall be as specified by the manufacturer's printed instructions.

150 PSI Model C Wafer Style Butterfly Valves

Scope:

This specification establishes the manufacturing requirements for PVC Butterfly Valves intended for use in industrial, commercial, and residential pressure-piping systems for non-corrosive or mildly corrosive applications, where the service temperature does not exceed 140° F.

Materials:

The body shall be manufactured from a PVC compound that meets the requirements of Cell Class 12454 polyvinyl chloride as outlined in ASTM D1784.

The disc shall be manufactured of ductile iron as specified in ASTM A395 with EPDM encapsulation.

The upper and lower shaft shall be manufactured from 416 stainless steel as specified in ASTM A582.

The O-ring seal material shall be manufactured from EPDM.

The bearing shall be manufactured from PTFE-coated bronze centered on steel.

The handle is of malleable iron with epoxy coating. The throttling index plates are made of zinc-plated steel.

Valve Design:

Valve body shall be of the wafer design for ease on installation and maintenance and shall be compatible with bolt hole pattern Class 150 ASME B16.5; BS 1560 class 150; DN 200 ISO 2084 PN 10; and DN 200 DIN 2532 PN 10.

The shaft is splined to lock into the disc to ensure positive rotation. The shaft is guided by PTFE-coated bearings to protect against deflection. Disc position is indicated by the shaft, when the handle is removed.

Laying length is compatible with MSS SP-67 narrow (W-1) and DN 200 ISO 5752 short.

Markings:

Valves shall be clearly marked with the manufacturer's name or trademark, nominal size, material designation, ASTM number or equivalent symbol indicating compliance with applicable standards, country of origin, and pressure rating.

Performance:

Valves shall be rated bubble-tight at 150 psi 73° F non-shock water service.

Installation:

Installation and operation shall be as specified by the manufacturer's printed instructions.

150 PSI Y-Pattern – Chemcock[®] – Calibrated Needle

Scope:

This specification establishes the manufacturing requirements for PVC Schedule 80 specialty valves for use in industrial, pressure-rated, fluid-handling systems in applications up to 140° F, where precise control and corrosion resistance are of prime importance.

Materials:

Rigid PVC (polyvinyl chloride) used in the manufacture of Schedule 80 valves shall be Cell Classification 12454 as identified in ASTM D1784.

Dimensions/Valve Design:

Valves utilizing threaded-end connections shall have thread lengths, diameters, and configurations as required by ASTM D2467 and ASTM F1498.

Hose-barb connections (Chemcock[®] Valve) shall be suitable for joining with ¼" to 3/8" I.D. measured flexible hose.

Valves intended for multi-turn throttling control shall be globe design in NPS ¼ – 1.

Y-Pattern for straight 180° installations using internal pipe threads and having double lead-thread stem control for rapid adjustment. Valves shall have glass-filled PTFE seats for positive shut-off and extended service-life and FKM seals for maximum protection against external leaks.

Angle valve for 90° installations using internal pipe threads and having double lead-thread stem control for rapid adjustment. Valves shall have glass-filled PTFE seats for positive shut-off and extended service-life and FKM seals for maximum protection against external leakage.

For maximum versatility, both A and B type valves shall have inter-changeable bonnet/stem assemblies.

Needle valves are intended for use in applications that require precise metering control. Needle valves shall have predictable flow patterns with (8) molded in increments on the body. These valves shall have PTFE seats and FKM seals for maximum service life and protection against external leakage. Needle valves have NPS ¼ internal pipe threaded ends.

Chemcock valves are intended for use in laboratory sampling applications. The Chemcock valves have NPS ¼ external thread-by-external thread-end connections; however, one end of the valve shall be capable of being changed to hose-threads for maximum versatility.

Pressure Ratings:

Valves shall be rated for 150 psi at 73° F non-shock water service and have a minimum burst requirement of 3.2 times the rated pressure.

Markings:

Valves shall be clearly marked with the manufacturer's name or trademark, nominal size, material designation, and country of manufacture. PVC and CPVC valves shall additionally bear the NSF International certification mark, NSF-pw, (verifying approval for conveyance of potable water).

Installation:

Installation and operation shall be as specified by the manufacturer's printed instructions.

Chemtrol One-Year Limited Warranty

CHEMTROL warrants each Chemtrol® pressure-rated Pipe, Valve, and Industrial Plastic Fitting to be free from defects in materials and workmanship for a period of one (1) year from the date of purchase under normal use and service within limitations recommended by it.

In the event any defect occurs which the owner believes is covered by this Warranty, the owner should immediately contact the authorized CHEMTROL distributor. The owner will be instructed to return said product at the owner's expense to CHEMTROL or an authorized CHEMTROL representative for inspection. In the event said inspection discloses to the satisfaction of CHEMTROL that said product is defective, appropriate action relating to credit or replacement shall be initiated.

THIS WARRANTY SPECIFICALLY EXCLUDES INCIDENTAL AND CONSEQUENTIAL DAMAGES OF EVERY TYPE AND DESCRIPTION RESULTING FROM ANY CLAIMED DEFECT IN MATERIAL OR WORKMANSHIP INCLUDING, BUT NOT LIMITED TO, PERSONAL INJURIES AND PROPERTY DAMAGES. Some states do not allow the exclusion or limitations of incidental or consequential damages so these limitations may not apply to you.

TO THE EXTENT PERMITTED BY LAW, IMPLIED WARRANTIES OF MERCHANTABILITY AND FITNESS FOR A PARTICULAR PURPOSE ARE LIMITED IN DURATION TO ONE (1) YEAR FROM THE TIME OF PURCHASE OF SAID VALVE OR FITTING. Some states do not allow limitations in how long an implied warranty lasts, so the above limitations may not apply to you.

This Warranty gives you specific legal rights, and you may also have other rights which vary from state to state.

How to Order

Chemtrol sells its products through select stocking distributors. Our distributors are knowledgeable of plastic applications as well as schooled in the complete Chemtrol product line. **For a listing of distributors in your area, please visit our website www.chemtrol.com.**

NIBCO INC. Customer Service

World Headquarters
1516 Middlebury Street
PO Box 1167
Elkhart, IN 46515-1167 Phone: 800.343.5455
U.S.A. Fax: 800.541.3841

To the best of our knowledge the information contained in this publication is accurate. However NIBCO/Chemtrol does not assume any liability whatsoever for the accuracy or completeness of such information. Final determination of the suitability of any information or product for the use to be contemplated is the sole responsibility of the user. The manner of use and whether or not such use may infringe the patent rights of any party is also the sole responsibility and liability of the user.

Technical Service

Our Technical Service Department is available to provide information and guidance on the suitability of Chemtrol products for specific applications. Recommendations and assistance are also available to engineering and contracting firms for installation specifications and personnel training.

Technical Service:	International Service:
Phone: 888.446.4226	Phone: +1.574.295.3221
Fax: 888.336.4226	Fax: +1.574.295.3455

www.chemtrol.com



Every solution
begins with
a good idea.

We've got ideas that flow directly to solutions for your industrial piping applications. Ideas that make your installations easier and more cost-effective. Ideas that work, and ideas that last. Our ideas are strengthened by a sound foundation for growth and a solid commitment to service.

NIBCO INC.
World Headquarters
1516 Middlebury Street
PO Box 1167
Elkhart, IN 46515-1167
USA

Phone: 800.343.5455
Fax: 800.541.3841

Technical Service:
Phone: 888.446.4226

International Service:
Phone: +1.574.295.3327
Fax: +1.574.295.3455

www.chemtrol.com

For ideas that fit your flow-control applications, call on us. We're Chemtrol, a product line committed to innovation, growth, and superiority in thermoplastics—ideas whose time has come.



C-CHP-0913

Corzan® is a registered trademark of The Lubrizol Corporation.
Tru-Bloc® is a registered trademark of NIBCO INC.
Chem-Pure® is a registered trademark of NIBCO INC.
Chemcock® is a registered trademark of NIBCO INC.
Kynar® is a registered trademark of Arkema Inc.